

Introduction to Toshiba Bias Resistor Built-in Transistors (Digital Transistors)

Toshiba has a lineup of transistors with built-in resistors (BRT: Bias Resistor Built-in Transistors) that combine various resistance values with NPN / PNP transistors (BJT: Bipolar junction transistors) in a small package.

Toshiba, a leading company in transistors

Since Toshiba succeeded in developing a transistor in 1951, it has been one of the major transistor vendors [Note] who have continued to market products as a pioneer in the industry since the early days of semiconductors. We will continue to provide a wide range of highly reliable transistor products based on our experience in delivering products to many customers.

[Note] according to a survey by Toshiba (as of March 1st, 2021)



High-quality, safe and secure delivery at plants in Japan and Thailand

Our transistor products are mainly surface-mount type small packages. High-quality, stable production at plants in Japan and Thailand enables safe and safety delivery. We will respond quickly and seriously to sudden delivery problems as well.

Bias Resistor Built-in Transistors (Digital Transistors) overview

It is a transistor with a resistor added between the base, base - emitter of the bipolar transistor. For this reason, the circuit configuration easier with fewer external components such as bias resistors. The main use is for switching. The following is an example of adding a resistor to the NPN transistor / PNP transistor.

NPN Transistor

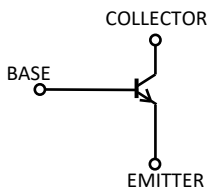

Add a resistor to the base terminal (input resistor)



Base terminal and base-emitter terminal Add resistance between

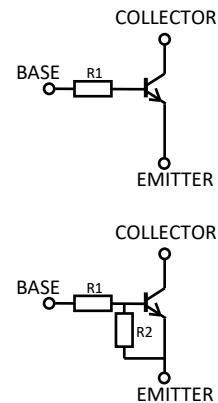

PNP Transistor

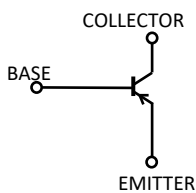

Add a resistor to the base terminal (input resistor)

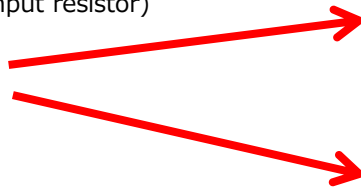

Base terminal and base-emitter terminal Add resistance between

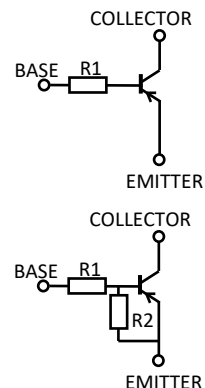

Bias Resistor Built-in Transistors (Digital Transistors) Selection guide

As shown in the figure below, we have a lineup, including 1in1 and 2in1 transistors with built-in resistors for NPN transistors and PNP transistors in the package.

Internal Connections

NPN type

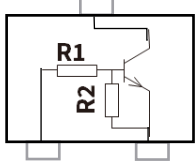
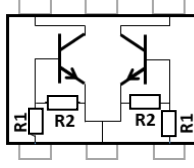
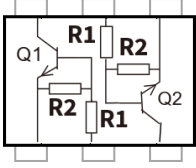
1in1	2in1	
NPN x 1	Common emitter NPN x 2	Point-symmetrical NPN x 2
		

PNP type

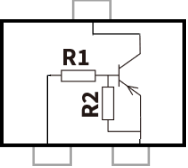
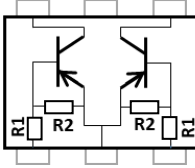
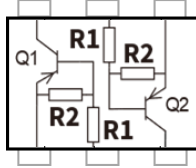



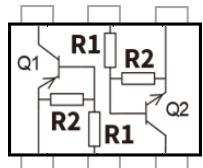
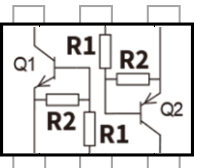







1in1	2in1	
PNP x 1	Common emitter NPN x 2	Point-symmetrical NPN x 2
		

NPN+PNP type

2in1	
Point-symmetrical PNP+NPN	Point-symmetrical NPN+PNP
	

• Bias Resistor Built-in Transistors (Digital Transistors) selection table

[Single product]

V_{CE0} (V)	I_{C1} (mA)	Resistance		VESM (SOT-723)  1.2x1.2		SSM (SOT-416)  1.6x1.6		USM (SOT-323)  2.0x2.1		S-Mini (SOT-346)  2.9x2.5	
		R1 (typ.)	R2 (typ.)								
		(k Ω)	(k Ω)	NPN		PNP		NPN		PNP	
		Part Number									
50	100	4.7	4.7	RN1101MFV	RN2101MFV	RN1101	RN2101	RN1301	RN2301	RN1401	RN2401
		10	10	RN1102MFV	RN2102MFV	RN1102	RN2102	RN1302	RN2302	RN1402	RN2402
		22	22	RN1103MFV	RN2103MFV	RN1103	RN2103	RN1303	RN2303	RN1403	RN2403
		47	47	RN1104MFV	RN2104MFV	RN1104	RN2104	RN1304	RN2304	RN1404	RN2404
		2.2	47	RN1105MFV	RN2105MFV	RN1105	RN2105	RN1305	RN2305	RN1405	RN2405
		4.7	47	RN1106MFV	RN2106MFV	RN1106	RN2106	RN1306	RN2306	RN1406	RN2406
		10	47	RN1107MFV	RN2107MFV	RN1107	RN2107	RN1307	RN2307	RN1407	RN2407
		22	47	RN1108MFV	RN2108MFV	RN1108	RN2108	RN1308	RN2308	RN1408	RN2408
		47	22	RN1109MFV	RN2109MFV	RN1109	RN2109	RN1309	RN2309	RN1409	RN2409
		4.7	-	RN1110MFV	RN2110MFV	RN1110	RN2110	RN1310	RN2310	RN1410	RN2410
		10	-	RN1111MFV	RN2111MFV	RN1111	RN2111	RN1311	RN2311	RN1411	RN2411
		22	-	RN1112MFV	RN2112MFV	RN1112	RN2112	RN1312	RN2312	RN1412	RN2412
		47	-	RN1113MFV	RN2113MFV	RN1113	RN2113	RN1313	RN2313	RN1413	RN2413
		1	10	RN1114MFV	RN2114MFV	RN1114	RN2114	RN1314	-	RN1414	RN2414
		2.2	10	RN1115MFV	RN2115MFV	RN1115	RN2115	RN1315	RN2315	RN1415	RN2415
		4.7	10	RN1116MFV	RN2116MFV	RN1116	RN2116	RN1316	RN2316	RN1416	RN2416
		10	4.7	RN1117MFV	RN2117MFV	RN1117	RN2117	RN1317	RN2317	RN1417	RN2417
		47	10	RN1118MFV	-	RN1118	-	RN1318	RN2318	RN1418	RN2418
		1	-	RN1119MFV	RN2119MFV	-	-	-	-	-	-
		100	100	RN1130MFV	RN2130MFV	-	-	-	-	-	-
100	-	RN1131MFV	RN2131MFV	-	-	-	-	-	-		
200	-	RN1132MFV	RN2132MFV	-	-	-	-	-	-		

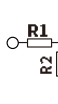
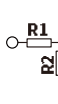
V_{CE0} (V)	I_{C1} (mA)	Resistance		SOT23 (SOT-23)  2.9x2.4	
		R1 (typ.)	R2 (typ.)		
		(k Ω)	(k Ω)	Part Number	
		50	100	4.7	4.7
10	10			TDTC114E	TDTA114E
22	22			TDTC124E	TDTA124E
47	47			TDTC144E	TDTA144E
2.2	47			TDTC123J	TDTA123J
4.7	47			TDTC143Z	TDTA143Z
10	47			TDTC114Y	TDTA114Y

• Bias Resistor Built-in Transistors (Digital Transistors) selection table

[2in1 product]

• Common emitter

V _{CE0} (V)	I _C (mA)	Resistance		ESV (SOT-553) 1.6x1.6		USV (SOT-353) 2.0x2.1		SMV (SOT-25) 2.9x2.8	
		R1 (typ.)	R2 (typ.)						
		(kΩ)	(kΩ)	Part Number					
50	100	4.7	4.7	RN1701JE	RN2701JE	RN1701	RN2701	RN1501	RN2501
		10	10	RN1702JE	RN2702JE	RN1702	RN2702	RN1502	RN2502
		22	22	RN1703JE	RN2703JE	RN1703	RN2703	RN1503	RN2503
		47	47	RN1704JE	RN2704JE	RN1704	RN2704	RN1504	RN2504
		2.2	47	RN1705JE	RN2705JE	RN1705	RN2705	RN1505	RN2505
		4.7	47	RN1706JE	RN2706JE	RN1706	RN2706	RN1506	RN2506
		10	47	RN1707JE	RN2707JE	RN1707	RN2707	RN1507	RN2507
		22	47	RN1708JE	RN2708JE	RN1708	RN2708	RN1508	-
		47	22	RN1709JE	RN2709JE	RN1709	RN2709	RN1509	-
		4.7	-	RN1710JE	RN2710JE	RN1710	RN2710	RN1510	RN2510
		10	-	RN1711JE	RN2711JE	RN1711	RN2711	RN1511	RN2511
		22	-	-	RN2712JE	-	-	-	-
		47	-	-	RN2713JE	-	-	-	-













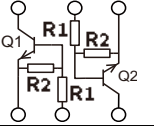
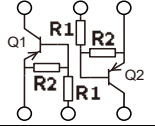
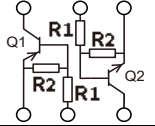
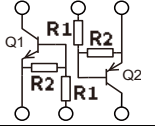

































• Point-symmetrical













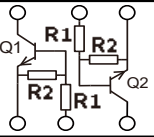
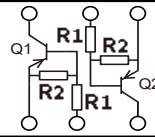
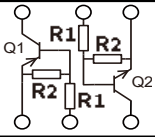





















V _{CE0} (V)	I _C (mA)	Resistance		ES6 (SOT-563) 1.6x1.6			
		R1 (typ.)	R2 (typ.)				
		(kΩ)	(kΩ)	Part Number			
50	100	4.7	4.7	RN1901FE	RN2901FE	RN4901FE	RN4981FE
		10	10	RN1902FE	RN2902FE	RN4902FE	RN4982FE
		22	22	RN1903FE	RN2903FE	RN4903FE	RN4983FE
		47	47	RN1904FE	RN2904FE	RN4904FE	RN4984FE
		2.2	47	RN1905FE	RN2905FE	RN4905FE	RN4985FE
		4.7	47	RN1906FE	RN2906FE	RN4906FE	RN4986FE
		10	47	RN1907FE	RN2907FE	RN4907FE	RN4987FE
		22	47	RN1908FE	RN2908FE	RN4908FE	RN4988FE
		47	22	RN1909FE	RN2909FE	RN4909FE	RN4989FE
		4.7	-	RN1910FE	RN2910FE	RN4910FE	RN4990FE
		10	-	RN1911FE	RN2911FE	RN4911FE	RN4991FE

•Bias Resistor Built-in Transistors (Digital Transistors) selection table

[2in1 product]

•Point-symmetrical

V _{CE0} (V)	I _C (mA)	Resistance		<div style="text-align: center;">  <p>US6 (SOT-363)</p>  <p>2.0x2.1</p> </div>			
		R1 (typ.)	R2 (typ.)				
		(kΩ)	(kΩ)	Part Number			
50	100	4.7	4.7	RN1901 	RN2901 	RN4901 	RN4981 
		10	10	RN1902 	RN2902 	RN4902 	RN4982 
		22	22	RN1903 	RN2903 	RN4903 	RN4983 
		47	47	RN1904 	RN2904 	RN4904 	RN4984 
		2.2	47	RN1905 	RN2905 	RN4905 	RN4985 
		4.7	47	RN1906 	RN2906 	RN4906 	RN4986 
		10	47	RN1907 	RN2907 	RN4907 	RN4987 
		22	47	RN1908 	RN2908 	RN4908 	RN4988 
		47	22	RN1909 	RN2909 	RN4909 	RN4989 
		4.7	-	RN1910 	RN2910 	RN4910 	RN4990 
		10	-	RN1911 	RN2911 	RN4911 	-
47/2.2	47/47	-	-	-	RN49A2 		

V _{CE0} (V)	I _C (mA)	Resistance		<div style="text-align: center;">  <p>SM6 (SOT-26)</p>  <p>2.9x2.8</p> </div>		
		R1 (typ.)	R2 (typ.)			
		(kΩ)	(kΩ)	Part Number		
50	100	4.7	4.7	RN1601 	RN2601 	RN4601 
		10	10	RN1602 	RN2602 	RN4602 
		22	22	RN1603 	RN2603 	RN4603 
		47	47	RN1604 	RN2604 	RN4604 
		2.2	47	RN1605 	RN2605 	RN4605 
		4.7	47	RN1606 	RN2606 	RN4606 
		10	47	RN1607 	RN2607 	RN4607 
		22	47	RN1608 	RN2608 	RN4608 
		47	22	RN1609 	-	RN4609 
		4.7	∞	RN1610 	RN2610 	RN4610 
		10	∞	RN1611 	-	RN4611 
22	∞	-	-	RN4612 		

LINK

- Parametric search [Click](#)
- Application Notes [Click](#)
- Frequently Asked Questions (FAQ) of BRT [Click](#)
- Stock Check & Purchase [Click](#)
- Cross Reference Search [Click](#)

*Company names, product names, and service names may be trademarks of their respective companies.

RESTRICTIONS ON PRODUCT USE

Toshiba Corporation and its subsidiaries and affiliates are collectively referred to as "TOSHIBA".

Hardware, software and systems described in this document are collectively referred to as "Product".

- TOSHIBA reserves the right to make changes to the information in this document and related Product without notice.
- This document and any information herein may not be reproduced without prior written permission from TOSHIBA. Even with TOSHIBA's written permission, reproduction is permissible only if reproduction is without alteration/omission.
- Though TOSHIBA works continually to improve Product's quality and reliability, Product can malfunction or fail. Customers are responsible for complying with safety standards and for providing adequate designs and safeguards for their hardware, software and systems which minimize risk and avoid situations in which a malfunction or failure of Product could cause loss of human life, bodily injury or damage to property, including data loss or corruption. Before customers use the Product, create designs including the Product, or incorporate the Product into their own applications, customers must also refer to and comply with (a) the latest versions of all relevant TOSHIBA information, including without limitation, this document, the specifications, the data sheets and application notes for Product and the precautions and conditions set forth in the "TOSHIBA Semiconductor Reliability Handbook" and (b) the instructions for the application with which the Product will be used with or for. Customers are solely responsible for all aspects of their own product design or applications, including but not limited to (a) determining the appropriateness of the use of this Product in such design or applications; (b) evaluating and determining the applicability of any information contained in this document, or in charts, diagrams, programs, algorithms, sample application circuits, or any other referenced documents; and (c) validating all operating parameters for such designs and applications. TOSHIBA ASSUMES NO LIABILITY FOR CUSTOMERS' PRODUCT DESIGN OR APPLICATIONS.
- PRODUCT IS NEITHER INTENDED NOR WARRANTED FOR USE IN EQUIPMENTS OR SYSTEMS THAT REQUIRE EXTRAORDINARILY HIGH LEVELS OF QUALITY AND/OR RELIABILITY, AND/OR A MALFUNCTION OR FAILURE OF WHICH MAY CAUSE LOSS OF HUMAN LIFE, BODILY INJURY, SERIOUS PROPERTY DAMAGE AND/OR SERIOUS PUBLIC IMPACT ("UNINTENDED USE"). Except for specific applications as expressly stated in this document, Unintended Use includes, without limitation, equipment used in nuclear facilities, equipment used in the aerospace industry, Class 3 medical devices, equipment used for automobiles, and military vehicles and munitions. IF YOU USE PRODUCT FOR UNINTENDED USE, TOSHIBA ASSUMES NO LIABILITY FOR PRODUCT. For details, please contact your TOSHIBA sales representative or contact us via our website.
- Do not disassemble, analyze, reverse-engineer, alter, modify, translate or copy Product, whether in whole or in part.
- Product shall not be used for or incorporated into any products or systems whose manufacture, use, or sale is prohibited under any applicable laws or regulations.
- The information contained herein is presented only as guidance for Product use. No responsibility is assumed by TOSHIBA for any infringement of patents or any other intellectual property rights of third parties that may result from the use of Product. No license to any intellectual property right is granted by this document, whether express or implied, by estoppel or otherwise.
- ABSENT A WRITTEN SIGNED AGREEMENT, EXCEPT AS PROVIDED IN THE RELEVANT TERMS AND CONDITIONS OF SALE FOR PRODUCT, AND TO THE MAXIMUM EXTENT ALLOWABLE BY LAW, TOSHIBA (1) ASSUMES NO LIABILITY WHATSOEVER, INCLUDING WITHOUT LIMITATION, INDIRECT, CONSEQUENTIAL, SPECIAL, OR INCIDENTAL DAMAGES OR LOSS, INCLUDING WITHOUT LIMITATION, LOSS OF PROFITS, LOSS OF OPPORTUNITIES, BUSINESS INTERRUPTION AND LOSS OF DATA, AND (2) DISCLAIMS ANY AND ALL EXPRESS OR IMPLIED WARRANTIES AND CONDITIONS RELATED TO SALE, USE OF PRODUCT, OR INFORMATION, INCLUDING WARRANTIES OR CONDITIONS OF MERCHANTABILITY, FITNESS FOR A PARTICULAR PURPOSE, ACCURACY OF INFORMATION, OR NONINFRINGEMENT.
- Do not use or otherwise make available Product or related software or technology for any military purposes, including without limitation, for the design, development, use, stockpiling or manufacturing of nuclear, chemical, or biological weapons or missile technology products (mass destruction weapons). Product and related software and technology may be controlled under the applicable export laws and regulations including, without limitation, the Japanese Foreign Exchange and Foreign Trade Law and the U.S. Export Administration Regulations. Export and re-export of Product or related software or technology are strictly prohibited except in compliance with all applicable export laws and regulations.
- Please contact your TOSHIBA sales representative for details as to environmental matters such as the RoHS compatibility of Product. Please use Product in compliance with all applicable laws and regulations that regulate the inclusion or use of controlled substances, including without limitation, the EU RoHS Directive. TOSHIBA ASSUMES NO LIABILITY FOR DAMAGES OR LOSSES OCCURRING AS A RESULT OF NONCOMPLIANCE WITH APPLICABLE LAWS AND REGULATIONS.

Toshiba Electronic Devices & Storage Corporation

<https://toshiba.semicon-storage.com/>