

TOSHIBA CMOS Linear Integrated Circuit Silicon Monolithic

TCR5FM series

Ultra high Ripple rejection ratio, 500 mA CMOS Low Dropout Regulator in ultra small package

1. Description

The TCR5FM series are CMOS general-purpose single-output voltage regulators with an on/off control input, featuring low dropout voltage and ultra high Ripple rejection ratio.

These voltage regulators are available in fixed output voltages between 0.9 V and 5.0 V and capable of driving up to 500 mA. They feature Overcurrent protection, Thermal shutdown and Auto-discharge.

The TCR5FM series is offered in the ultra small plastic mold package DFN4D (1.0 mm x 1.0 mm; t 0.37 mm (Typ.)) and has a high ripple rejection ratio of 91 dB (f = 1 kHz, 2.8 V output). As small ceramic input and output capacitors 1 μ F can be used with the TCR5FM series, these devices are ideal for portable applications that require high-density board assembly such as cellular phones.

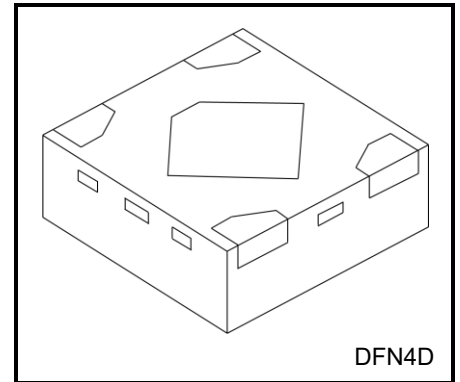

Weight: 1.1 mg (Typ.)

2. Applications

Power IC developed for portable applications

3. Features

- Ultra Small Package DFN4D (1.0 mm x 1.0 mm; t 0.37 mm (Typ.)).
- High Ripple Rejection Ratio
 - 91 dB (Typ.) @1 kHz at 2.8 V-output
 - 89 dB (Typ.) @10 kHz at 2.8 V-output
 - 67 dB (Typ.) @100 kHz at 2.8 V-output
 - 59 dB (Typ.) @1 MHz at 2.8 V-output
- Low Output Noise Voltage ($V_{NO} = 5 \mu V_{rms}$ (Typ.) at $10 \text{ Hz} \leq f \leq 100 \text{ kHz}$)
- Low Quiescent Current ($I_B = 10 \mu A$ (Typ.) at $I_{OUT} = 0 \text{ mA}$)
- Low Dropout Voltage
 - $V_{DO} = 220 \text{ mV}$ (Typ.) at 2.8 V-output, $I_{OUT} = 500 \text{ mA}$
- Fast Load Transient Response
 - $\Delta V_{OUT} = -60 \text{ mV}/+40 \text{ mV}$ (Typ.) at $I_{OUT} = 1 \text{ mA} \leftrightarrow 500 \text{ mA}$, 2.8 V-output
 - $\Delta V_{OUT} = -75 \text{ mV}/+25 \text{ mV}$ (Typ.) at $I_{OUT} = 0 \text{ mA} \leftrightarrow 100 \text{ mA}$, 2.8 V-output
- Overcurrent Protection
- Slew Rate Control Function aimed at suppressing inrush current
- Thermal Shutdown
- Auto-Discharge
- Wide Range Output Voltage Lineup ($V_{OUT} = 0.9 \text{ to } 5.0 \text{ V}$)
- Pull Down Connection between CONTROL and GND
- Ceramic capacitors can be used ($C_{IN} = 1.0 \mu F$, $C_{OUT} = 1.0 \mu F$)

Start of commercial production
2025-08

4. Absolute Maximum Ratings (Note) (Ta = 25°C)

Characteristics	Symbol	Rating	Unit
Input voltage	V _{IN}	-0.3 to 6.0	V
Control voltage	V _{CT}	-0.3 to 6.0	V
Output voltage	V _{OUT}	-0.3 to V _{IN} + 0.3 ≤ 6.0	V
Power dissipation	P _D	420 (Note1)	mW
Junction temperature	T _j	150	°C
Storage temperature range	T _{stg}	-55 to 150	°C

Note: Using continuously under heavy loads (e.g. the application of high temperature/current/voltage and the significant change in temperature, etc.) may cause this product to decrease in the reliability significantly even if the operating conditions (i.e. operating temperature/current/voltage, etc.) are within the absolute maximum ratings and the operating ranges.

Please design the appropriate reliability upon reviewing the Toshiba Semiconductor Reliability Handbook (“Handling Precautions”/“Derating Concept and Methods”) and individual reliability data (i.e. reliability test report and estimated failure rate, etc).

Note1: Rating at mounting on a board

Glass epoxy(FR4) board dimension: 40mm x 40mm x 1.6mm, both sides of board.

Metal pattern ratio: a surface approximately 50%, the reverse side approximately 50%

5. Pin Assignment (Top view)

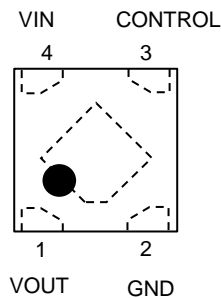

Note: Center electrode should be connected to GND or Open

6. Operating Ranges

Characteristics	Symbol	Rating	Unit
Input voltage	V _{IN}	1.55 to 5.5 (Note 2)	V
Control voltage	V _{CT}	0 to 5.5	V
Output voltage	V _{OUT}	0.9 to 5.0	V
Output current	I _{OUT}	DC 500	mA
Operation Temperature	T _{opr}	-40 to 125 (Note 3)	°C
Output Capacitance	C _{OUT}	≥ 1.0 μF	—
Input Capacitance	C _{IN}	≥ 1.0 μF	—

Note 2: Please refer to Dropout Voltage table (Page 6) and use it within Absolute Maximum Ratings Junction temperature and Operating Temperature Ranges.

Note 3: Do not operate at or near the maximum ratings of operating ranges for extended periods of time. Exposure to such conditions may adversely impact product reliability and results in failures not covered by warranty. Maximum output current of operating ranges table is defined as lifetime average junction temperature of 107°C where maximum output current = lifetime average current to avoid electro migration.

7. List of Products Number, Output voltage and Marking

Product No.	Output voltage(V)	Marking
TCR5FM09A	0.9	0W9
TCR5FM095A*	0.95	0WK
TCR5FM10A*	1.0	1W0
TCR5FM105A*	1.05	1WA
TCR5FM11A*	1.1	1W1
TCR5FM115A*	1.15	1WB
TCR5FM12A	1.2	1W2
TCR5FM125A*	1.25	1WC
TCR5FM13A*	1.3	1W3
TCR5FM15A*	1.5	1W5
TCR5FM16A*	1.6	1W6
TCR5FM17A*	1.7	1W7
TCR5FM18A	1.8	1W8
TCR5FM1825A	1.825	1WL
TCR5FM185A*	1.85	1WJ
TCR5FM19A*	1.9	1W9
TCR5FM20A*	2.0	2W0
TCR5FM22A	2.2	2W2
TCR5FM225A	2.25	2WC
TCR5FM25A*	2.5	2W5
TCR5FM26A*	2.6	2W6
TCR5FM27A*	2.7	2W7
TCR5FM28A	2.8	2W8
TCR5FM285A	2.85	2WJ
TCR5FM29A	2.9	2W9
TCR5FM30A	3.0	3W0
TCR5FM31A*	3.1	3W1
TCR5FM32A*	3.2	3W2
TCR5FM33A*	3.3	3W3
TCR5FM35A*	3.5	3W5
TCR5FM36A*	3.6	3W6
TCR5FM41A*	4.1	4W1
TCR5FM42A*	4.2	4W2
TCR5FM45A*	4.5	4W5
TCR5FM50A	5.0	5W0

Please ask your local retailer about the devices with (*) or other output voltages.

Top Marking (Top view)

Example: TCR5FM28A (2.8 V output)

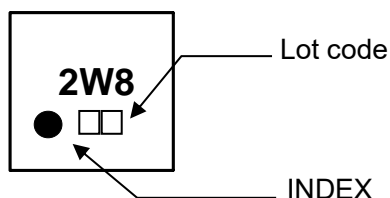

8. Block Diagram

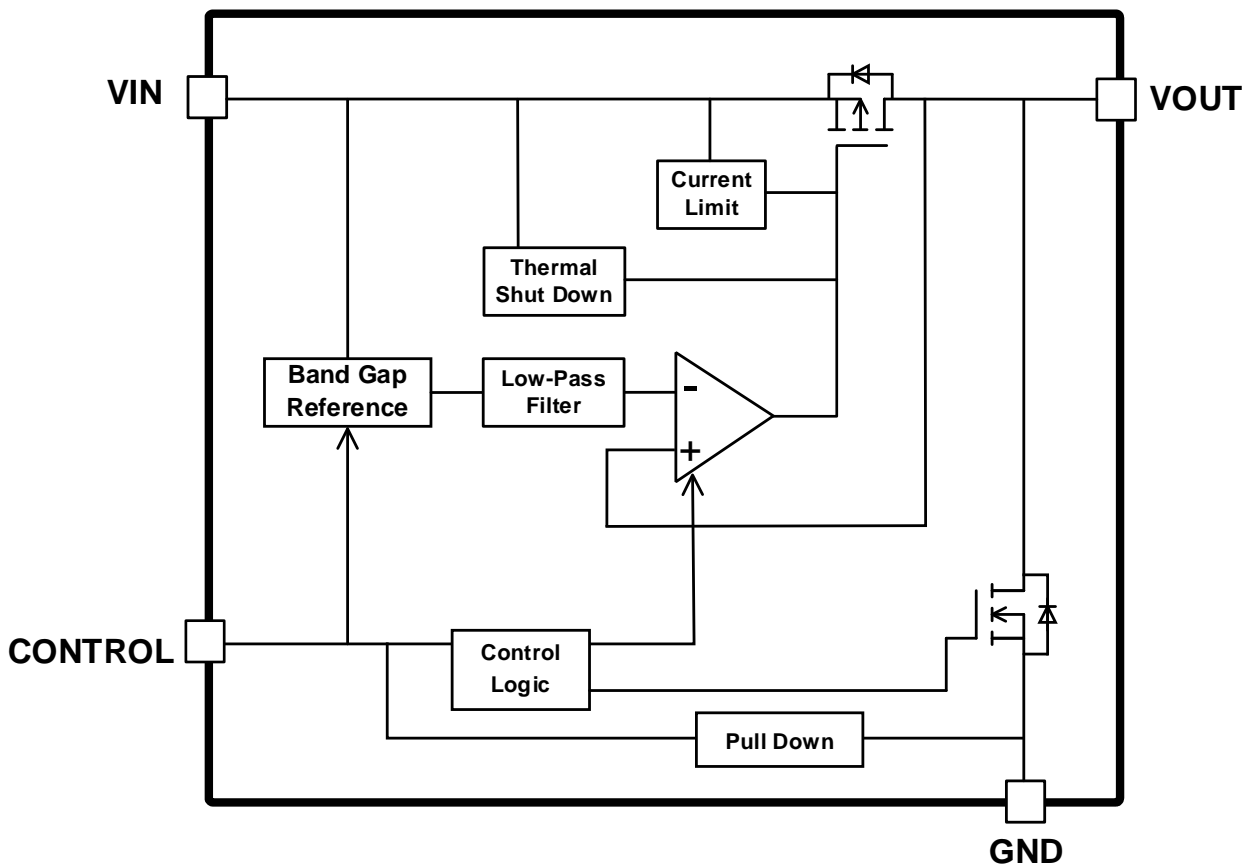

9. Electrical Characteristics

(Unless otherwise specified, $V_{IN} = V_{OUT} + 0.5\text{ V}$ or 2 V (whichever is greater), $C_{IN} = C_{OUT} = 1.0\ \mu\text{F}$)

Characteristics	Symbol	Test Condition	$T_j = 25^\circ\text{C}$			$T_j = -40\text{ to }125^\circ\text{C}$ (Note 8)		Unit	
			Min	Typ.	Max	Min	Max		
Output voltage accuracy	V_{OUT}	$I_{OUT} = 1\text{ to }500\text{ mA}$ (Note 4)	$V_{OUT} \leq 1.25\text{ V}$	—	—	—	-45	+45	mV
			$1.25\text{ V} < V_{OUT} < 1.8\text{ V}$	—	—	—	-48	+48	mV
			$1.8\text{ V} \leq V_{OUT} < 2.2\text{ V}$	—	—	—	-2.8	+2.8	%
			$2.2\text{ V} \leq V_{OUT} < 2.8\text{ V}$	—	—	—	-2.5	+2.5	%
			$2.8\text{ V} \leq V_{OUT}$	—	—	—	-2.2	+2.2	%
Line regulation	Reg·line	$I_{OUT} = 1\text{ mA}$ (Note 5)	—	1.5	—	—	—	mV	
Load regulation	Reg·load	$1\text{ mA} \leq I_{OUT} \leq 500\text{ mA}$	—	20	—	—	—	mV	
Quiescent current	$I_{B(ON)}$	$I_{OUT} = 0\text{ mA}$ (Note 6)	—	10	—	—	20	μA	
Stand-by current	$I_{B(OFF)}$	$V_{CT} = 0\text{ V}$	—	0.1	—	—	0.8	μA	
Control pull down current	I_{CT}	—	—	0.1	—	—	0.2	μA	
Drop-out voltage (Note 9)	V_{DO}	$I_{OUT} = 500\text{ mA}$ (Note 5)	—	220	—	—	337	mV	
Output noise voltage	V_{NO}	$I_{OUT} = 10\text{ mA}$ $10\text{ Hz} \leq f \leq 100\text{ kHz}$ (Note 5)	—	5	—	—	—	μV_{rms}	
Ripple rejection ratio	R.R.	$I_{OUT} = 10\text{ mA}$, $V_{Ripple} = 200\text{ mV}_{p-p}$, (Note 5)	$f = 1\text{ kHz}$	—	91	—	—	—	dB
			$f = 10\text{ kHz}$	—	89	—	—	—	dB
			$f = 100\text{ kHz}$	—	67	—	—	—	dB
			$f = 1\text{ MHz}$	—	59	—	—	—	dB
Load transient response	ΔV_{OUT}	$I_{OUT} = 1\text{ mA} \rightarrow 500\text{ mA}$, $t_r = 1\ \mu\text{s}$ (Note 5)	—	-60	—	—	—	mV	
		$I_{OUT} = 500\text{ mA} \rightarrow 1\text{ mA}$, $t_f = 1\ \mu\text{s}$ (Note 5)	—	+40	—	—	—	mV	
		$I_{OUT} = 0\text{ mA} \rightarrow 100\text{ mA}$, $t_r = 1\ \mu\text{s}$ (Note 5)	—	-75	—	—	—	mV	
		$I_{OUT} = 100\text{ mA} \rightarrow 0\text{ mA}$, $t_f = 1\ \mu\text{s}$ (Note 5)	—	+25	—	—	—	mV	
Output voltage slew rate	V_{OUTSR}	(Note 5)	—	5	—	—	—	$\text{mV}/\mu\text{s}$	
Output current limit	I_{CL}	$V_{OUT} = V_{OUT(NOM)} * 90\%$ (Note 7)	—	—	—	500	1090	mA	
Thermal shutdown threshold	T_{SDH}	T_j rising	—	160	—	—	—	$^\circ\text{C}$	
	T_{SDL}	T_j falling	—	140	—	—	—	$^\circ\text{C}$	
Control pin voltage (HIGH)	V_{CTH}	Control pin input voltage "HIGH"	—	—	—	0.79	5.5	V	
Control pin voltage (LOW)	V_{CTL}	Control pin input voltage "LOW"	—	—	—	0	0.4	V	
Fast mode and Low I_B mode switching threshold current	I_{OUTF}	I_{OUT} rising (Low I_B mode to Fast mode)	—	150	—	—	290	μA	
	I_{OUTL}	I_{OUT} falling (Fast mode to Low I_B mode)	—	10	—	2	—	μA	
Discharge on resistance	R_{SD}	(Note 5)	—	30	—	—	—	Ω	

Note 4: stable state with fixed I_{OUT} condition

Note 5: $V_{OUT} = 2.8\text{ V}$

Note 6: except Control pull down current (I_{CT})

Note 7: Pulse measurement

Note 8: This parameter is warranted by design.

Note 9: $V_{DO} = V_{IN1} - (V_{OUT1} \times 0.97)$

V_{OUT1} is the output voltage when $V_{IN} = V_{OUT} + 0.5\text{ V}$.

V_{IN1} is the input voltage at which the output voltage becomes 97% of V_{OUT1} after gradually decreasing the input voltage.

10. Dropout voltage table

($C_{IN} = 1.0 \mu\text{F}$, $C_{OUT} = 1.0 \mu\text{F}$)

Output voltages	$I_{OUT} = 500 \text{ mA}$			Unit
	Min	Typ.	Max (Note 10)	
0.9 V, 0.95 V	—	860 (Note 11)	982 (Note 11)	mV
1.0 V, 1.05 V	—	790 (Note 11)	929 (Note 11)	mV
1.1 V, 1.15 V	—	730 (Note 11)	876 (Note 11)	mV
1.2 V, 1.25 V	—	670	822	mV
1.3 V	—	610	768	mV
1.5 V	—	490	659	mV
1.6 V	—	440	603	mV
1.7 V	—	390	547	mV
1.8 V, 1.825 V, 1.85 V	—	340	491	mV
1.9 V	—	320	471	mV
2.0 V	—	310	451	mV
2.2 V, 2.25 V	—	300	411	mV
2.5 V	—	250	372	mV
2.6 V	—	240	361	mV
2.7 V	—	230	349	mV
$2.8 \text{ V} \leq V_{OUT} \leq 3.0 \text{ V}$	—	220	337	mV
$3.1 \text{ V} \leq V_{OUT} \leq 3.6 \text{ V}$	—	210	328	mV
$4.1 \text{ V} \leq V_{OUT} \leq 4.5 \text{ V}$	—	180	297	mV
5.0 V	—	160	264	mV

Note 10: $T_j = -40$ to $125 \text{ }^\circ\text{C}$. This parameter is warranted by design.

Note 11: Operating Voltage of V_{IN} should be over 2.0 V.

11. Application Note

11.1. Recommended Application Circuit

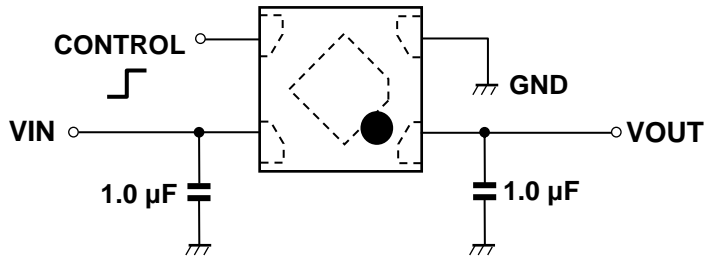

CONTROL voltage	Output voltage
HIGH	ON
LOW	OFF
OPEN	OFF

The figure above shows the recommended configuration for using a Low-Dropout regulator. Insert a capacitor at VOUT and VIN pins for stable input/output operation. (Ceramic capacitors can be used).

11.2. Power Dissipation

Board-mounted power dissipation ratings for TCR5FM series are available in the Absolute Maximum Ratings table. Power dissipation is measured on the board condition shown below.

[The Board Condition]

Board material: Glass epoxy (FR4)

Board dimension: 40 mm x 40 mm (both sides of board), t = 1.6 mm

Metal pattern ratio: a surface approximately 50%, the reverse side approximately 50%

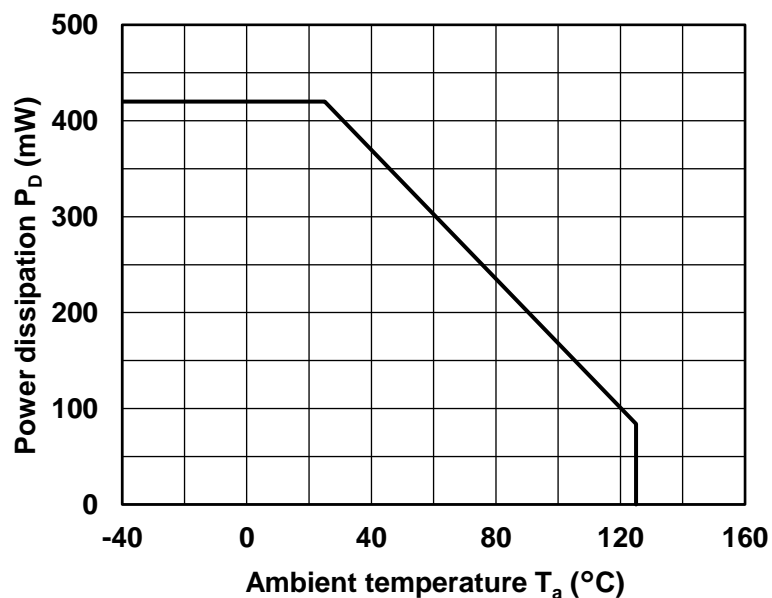

11.3. Attention in Use

- **Output Capacitors**

Toshiba recommends using ceramic capacitors for these devices. However, because of the type of the capacitors, there might be greatly affected by thermal features and DC bias depending. Please secure an effective capacitance of 0.5 μ F or more by considering application condition for selecting capacitors.
- **Bias current characteristics**

TCR5FM series has two modes (Low I_B mode, Fast mode). These modes are controlled by mode switching threshold current, I_{OUTF} and I_{OUTL} . When the output current required is very low, TCR5FM series operates with low $I_{B(ON)}$ (Low I_B mode). In this state, ripple rejection ratio characteristic and load transient response characteristic are inferior to Fast mode. Regarding two mode switches depending on I_{OUT} , it has hysteresis. When output current is increased, good Ripple rejection ratio characteristics and good load transient response characteristics are provided with $I_{B(ON)}$ becoming high (Fast mode). In the case of decreasing the I_{OUT} , TCR5FM series keeps good characteristics until the $I_{B(ON)}$ switches to a low state.
- **Mounting**

The long distance between IC and output capacitor might affect phase assurance by impedance in wire and inductor. For stable power supply, output capacitor needs to mount near IC as much as possible. Also, V_{IN} and GND pattern need to be large and make the wire impedance small as possible.
- **Permissible Loss**

Please have enough design patterns for expected maximum permissible loss. And under consideration of surrounding temperature, input voltage, and output current etc., we recommend proper dissipation ratings for maximum permissible loss; in general maximum dissipation rating is 70 to 80%.
- **Over current Protection and Thermal shutdown function**

Over current protection and Thermal shutdown function are designed in these products, but these are not designed to constantly ensure the suppression of the device within operation limits. Depending on the condition during actual usage, it could affect the electrical characteristic specification and reliability. Also note that if output pins and GND pins are not completely shorted out, these products might be break down. When using these products, please read through and understand the concept of dissipation for absolute maximum ratings from the above mention or our 'Semiconductor Reliability Handbook'. Then use these products under absolute maximum ratings in any condition. Furthermore, Toshiba recommends inserting failsafe system into the design.
- **High ripple rejection ratio and low output noise voltage characteristics**

TCR5FM series has low-pass filter which contributes high ripple rejection ratio and low output noise voltage. This low-pass filter turns on after V_{OUT} becomes near the nominal V_{OUT} , and the filter turn on time changes depend on usage condition, surrounding circuit and surrounding temperature. Therefore, please design with full consideration of usage condition. For example, the filter turn on time is approximately 10 ms in $V_{IN} = V_{OUT} + 0.5$ V, $T_a = 25^\circ\text{C}$ condition. Before and when the low-pass filter is turned on, please be careful about the increase and decrease of V_{OUT} such as CONTROL voltage from low to high and load transient response. It affects significantly especially when the voltage difference between V_{IN} and V_{OUT} is small.
- **Line Transient Response**

V_{OUT} may fluctuate when a sudden V_{IN} change is input. If V_{OUT} fluctuation is problem for usage, please consider measures such as adjusting C_{IN} to reduce V_{IN} change.

12. Representative Typical Characteristics (Note)

12.1. Output Voltage vs. Output Current

($V_{IN} = 2.0\text{ V}$ or $V_{OUT} + 0.5\text{ V}$ (whichever is greater))

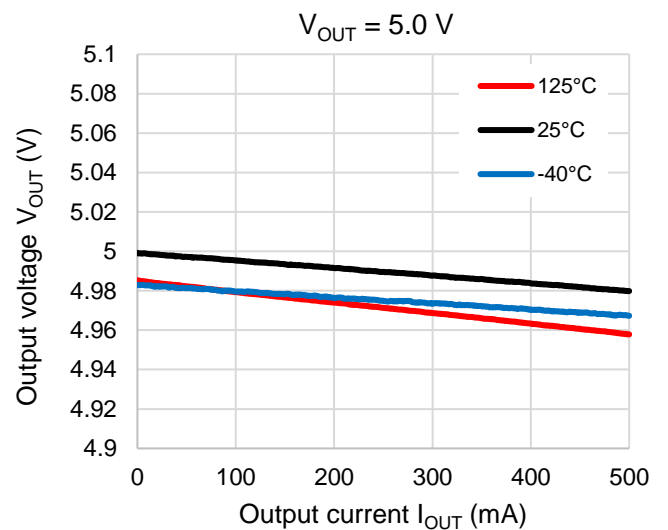
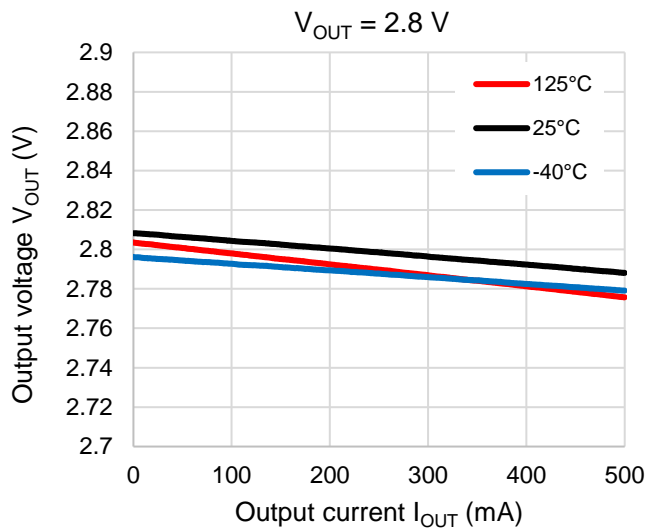
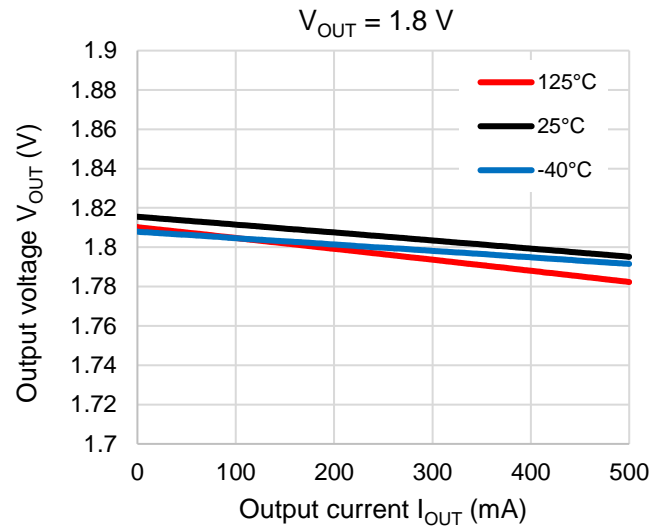
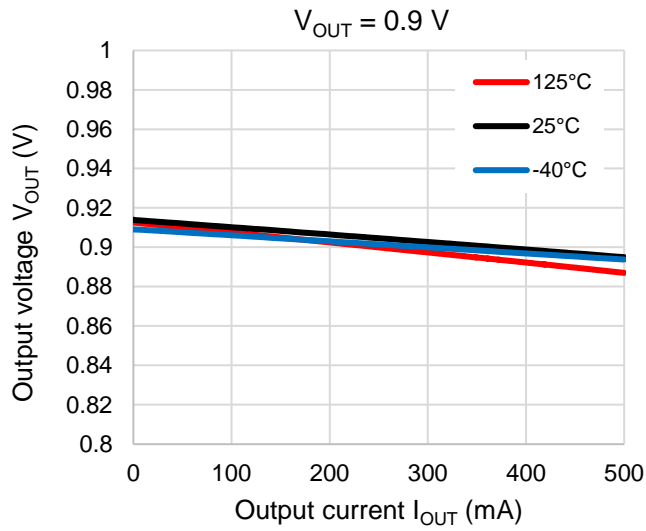

Note: The above characteristics curves are presented for reference only and not guaranteed by production test, unless otherwise noted.

12.2. Dropout Voltage vs. Output Current

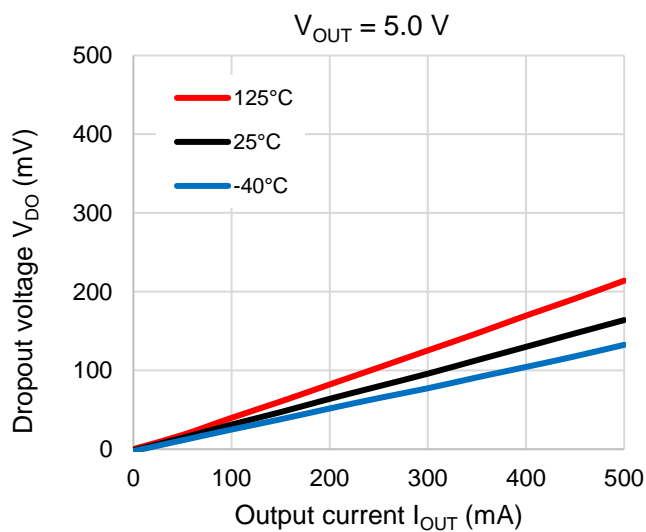
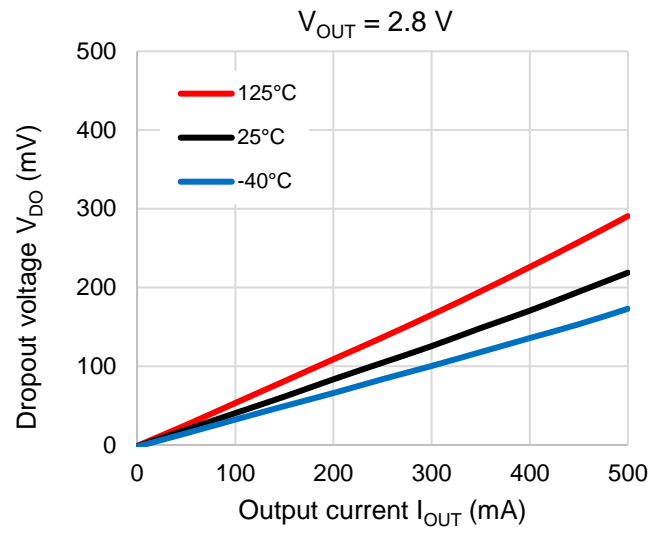
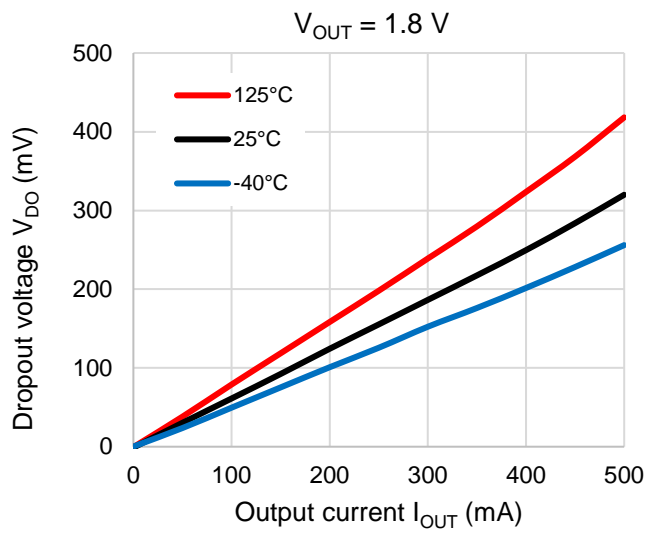

Note: The above characteristics curves are presented for reference only and not guaranteed by production test, unless otherwise noted.

12.3. Quiescent Current vs. Input Voltage ($I_{OUT} = 0 \text{ mA}$)

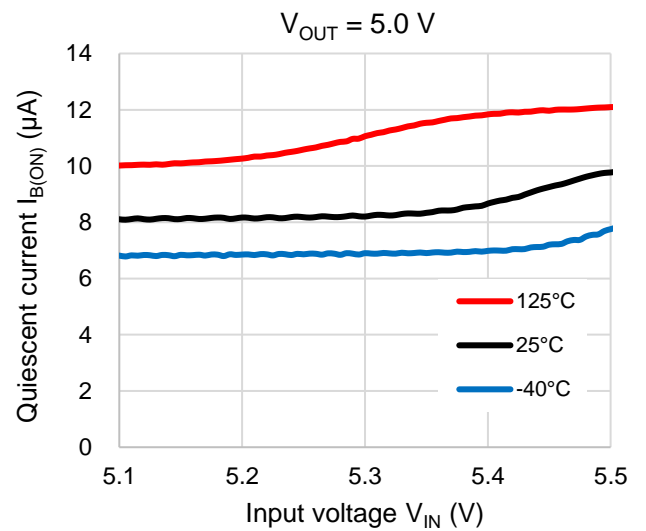
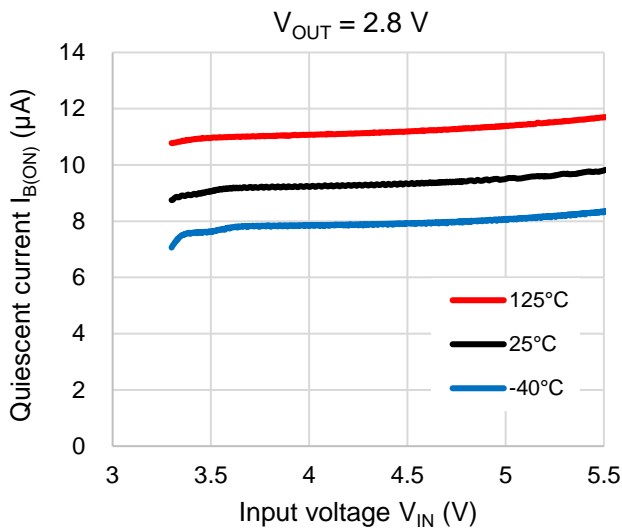
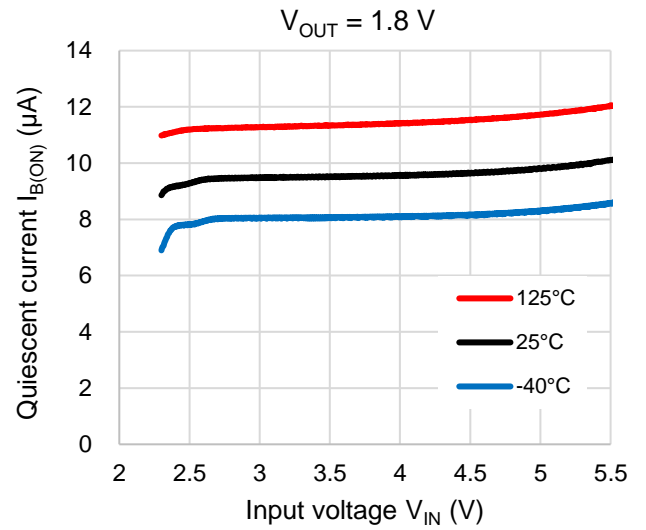
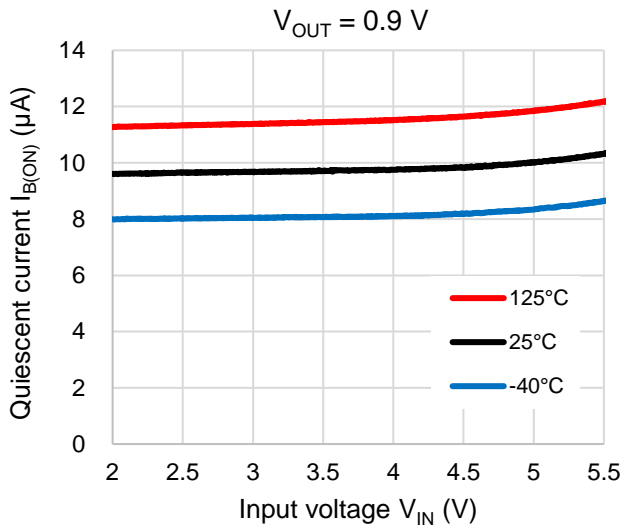

Note: The above characteristics curves are presented for reference only and not guaranteed by production test, unless otherwise noted.

12.4. Quiescent Current vs. Output Current

($V_{IN} = 2.0\text{ V}$ or $V_{OUT} + 0.5\text{ V}$ (whichever is greater))

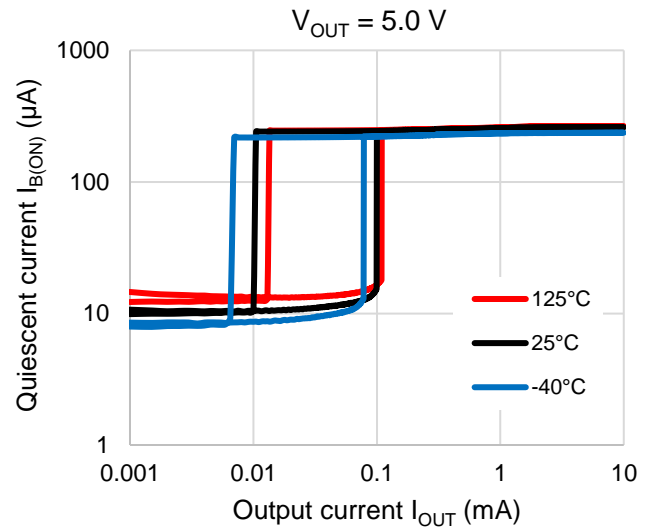
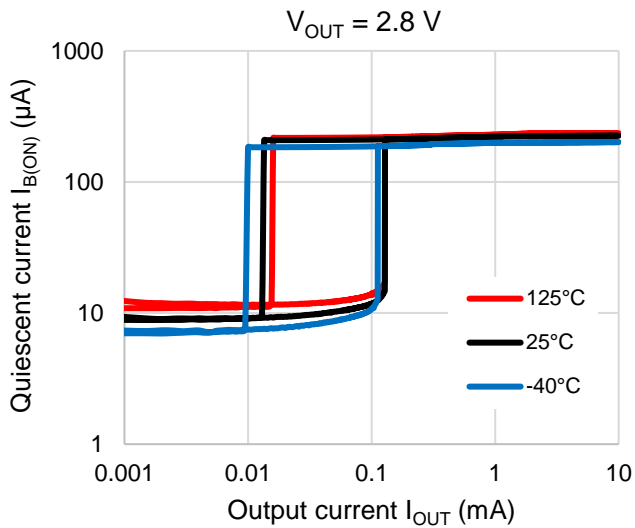
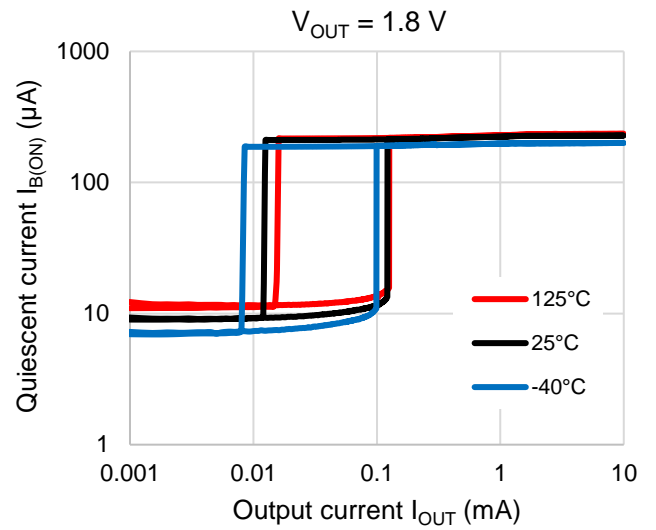
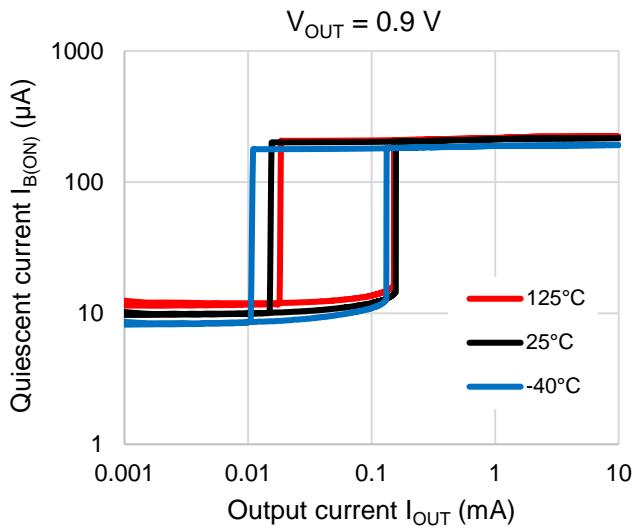

Note: The above characteristics curves are presented for reference only and not guaranteed by production test, unless otherwise noted.

12.5. Output Current Limit

($V_{IN} = 2.0\text{ V}$ or $V_{OUT} + 0.5\text{ V}$ (whichever is greater), $T_a = 25^\circ\text{C}$)

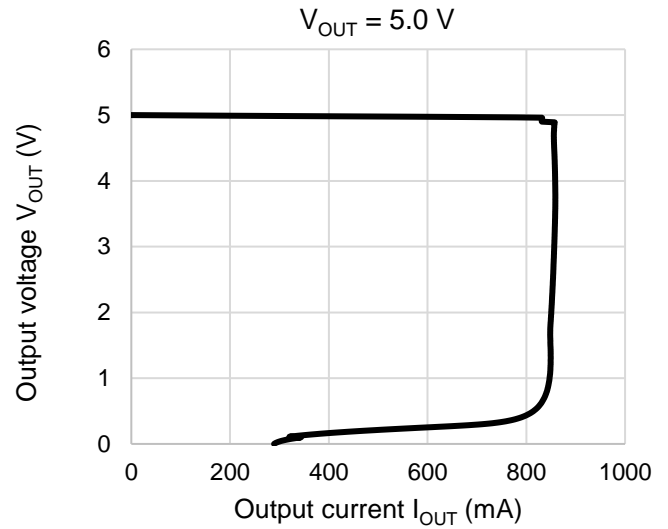
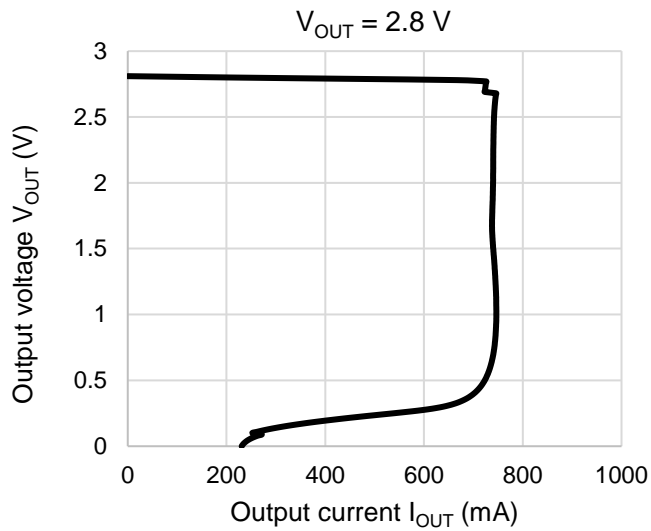
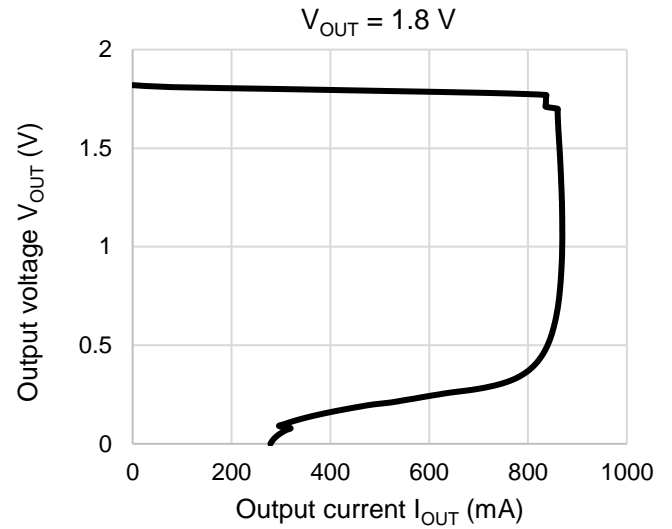
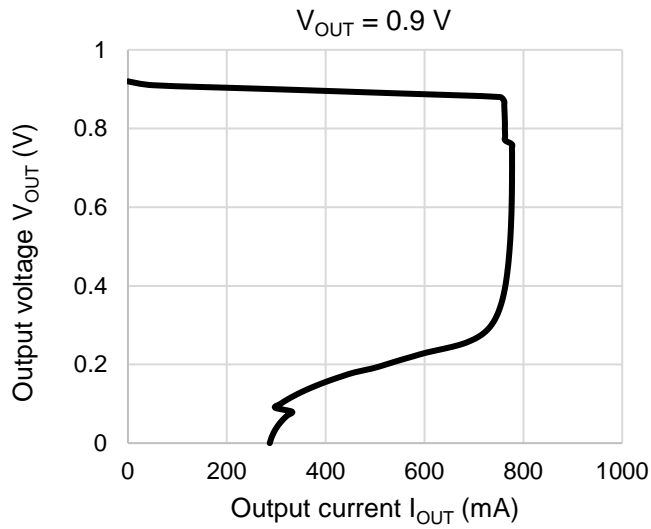

Note: The above characteristics curves are presented for reference only and not guaranteed by production test, unless otherwise noted.

12.6. Ripple rejection Ratio vs. Frequency

(C_{IN} = none, C_{OUT} = 1.0 μ F, V_{IN} = 2.0 V or V_{OUT} + 0.5 V (whichever is greater), V_{IN} Ripple = 200 mV_{p-p}, I_{OUT} = 10 mA, T_a = 25°C)

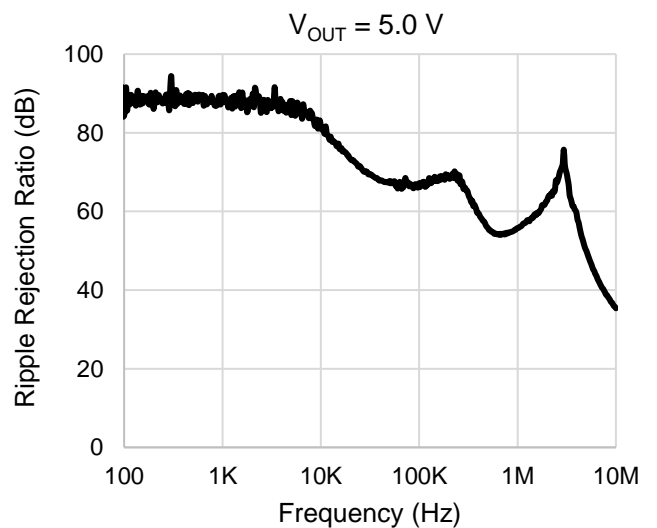
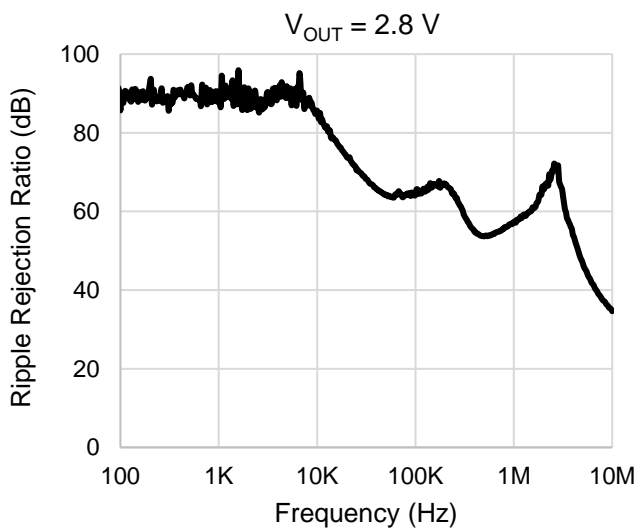
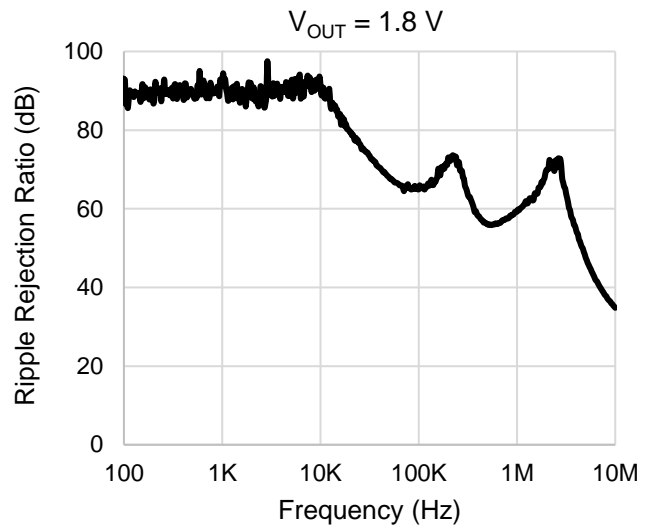
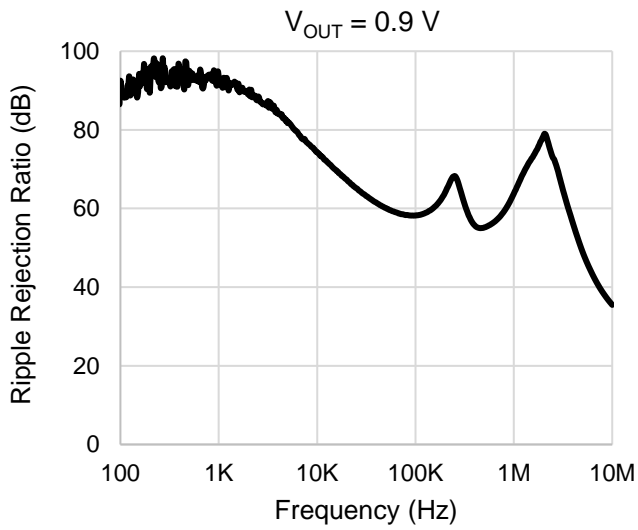

Note: The above characteristics curves are presented for reference only and not guaranteed by production test, unless otherwise noted.

12.7. Output noise Voltage

($C_{IN} = 1.0 \mu\text{F}$, $C_{OUT} = 1.0 \mu\text{F}$, $V_{IN} = 2.0 \text{ V}$ or $V_{OUT} + 0.5 \text{ V}$ (whichever is greater), $I_{OUT} = 10 \text{ mA}$, $T_a = 25^\circ\text{C}$)

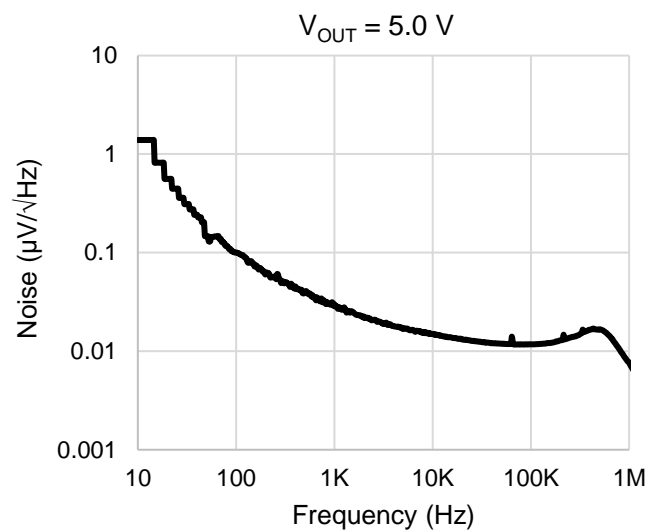
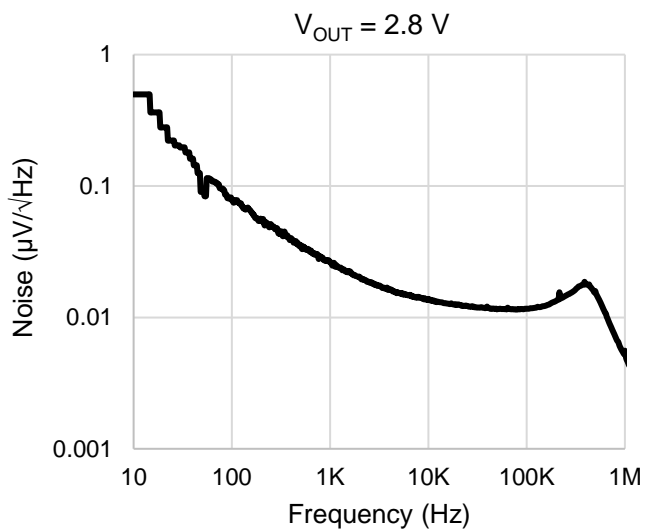
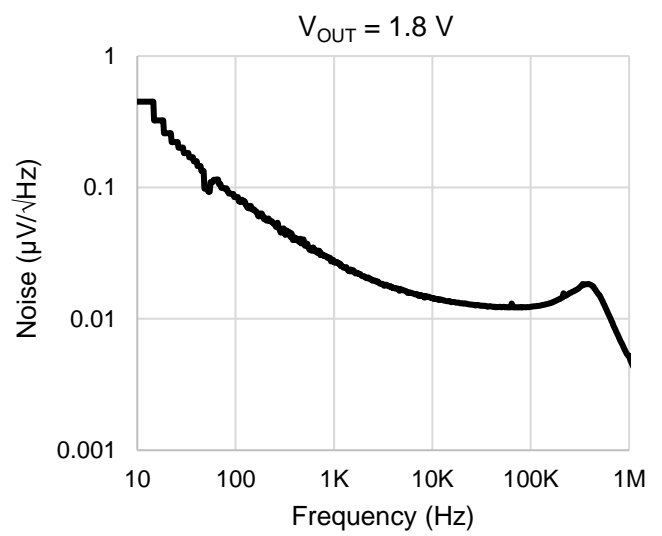
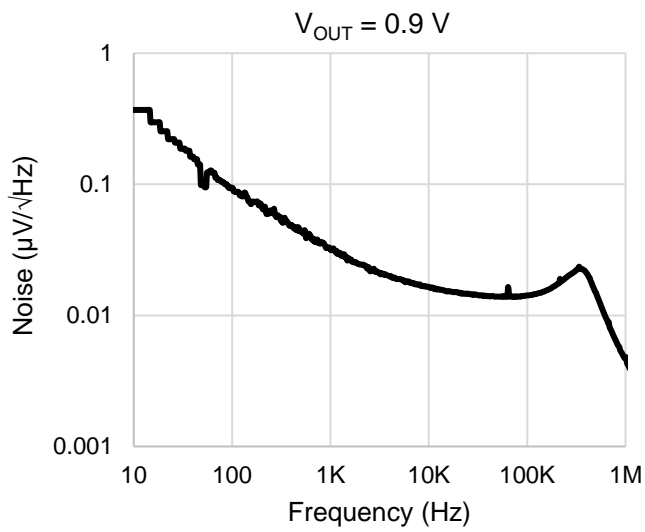

Note: The above characteristics curves are presented for reference only and not guaranteed by production test, unless otherwise noted.

12.8. t_{ON} / t_{OFF} Response

($C_{IN} = 1.0 \mu F$, $V_{IN} = 2.0 V$ or $V_{OUT} + 0.5 V$ (whichever is greater), $V_{CONTROL} = 0 V \leftrightarrow 1.0 V$, $T_a = 25^\circ C$)

- $C_{OUT} = 1.0 \mu F$, $I_{OUT} = 0 mA$

$V_{OUT} = 0.9 V$

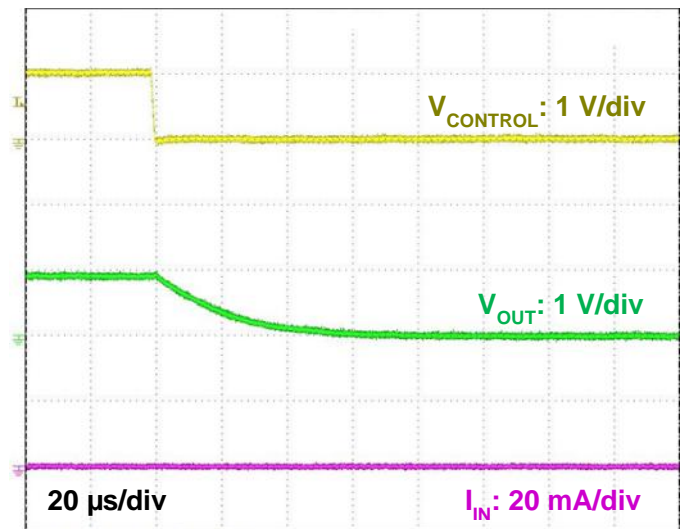
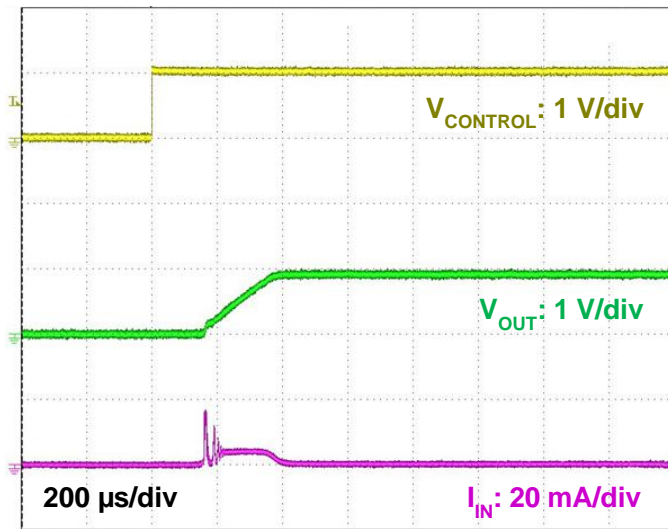

$V_{OUT} = 1.8 V$

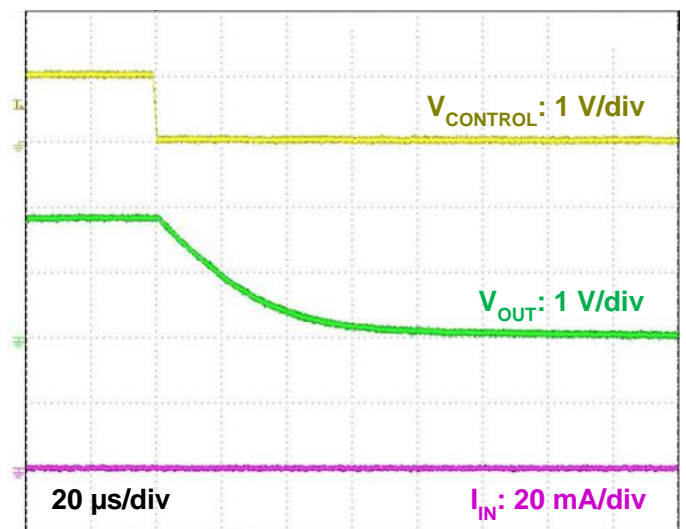
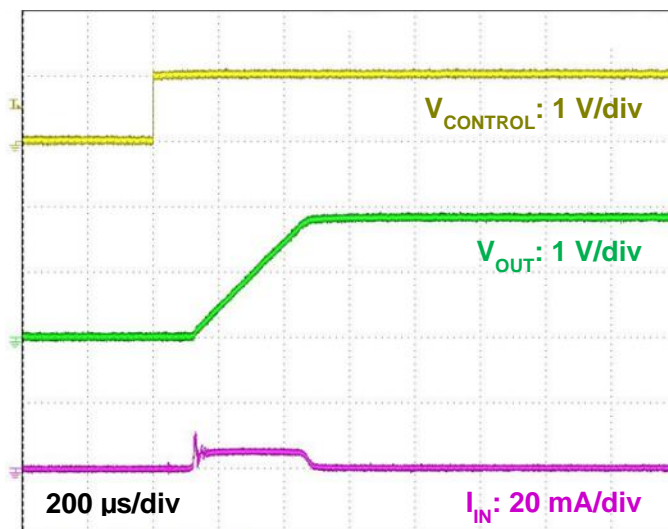

Note: The above characteristics curves are presented for reference only and not guaranteed by production test, unless otherwise noted.

t_{ON} / t_{OFF} Response

(C_{IN} = 1.0 μF, V_{IN} = 2.0 V or V_{OUT} + 0.5 V (whichever is greater), V_{CONTROL} = 0 V ↔ 1.0 V, T_a = 25°C)

- C_{OUT} = 1.0 μF, I_{OUT} = 0 mA

V_{OUT} = 2.8 V

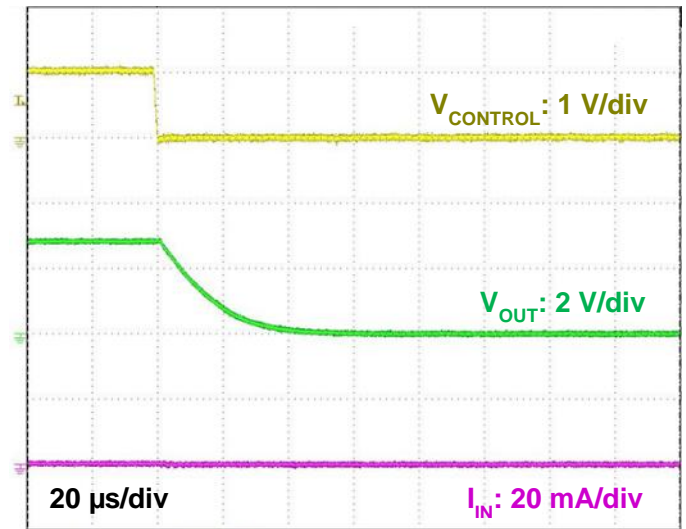
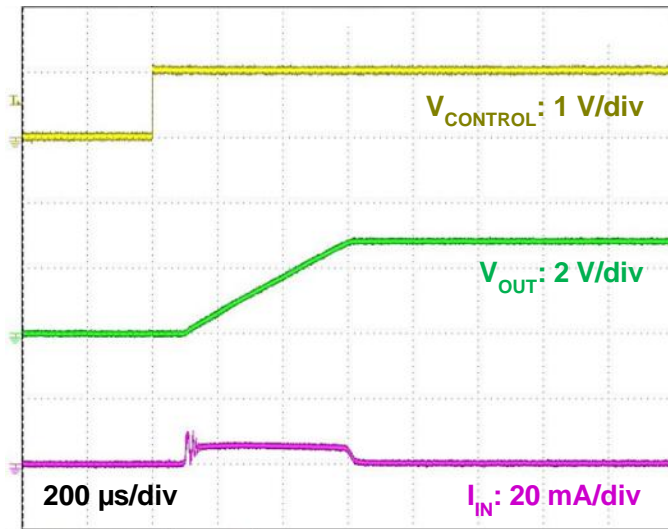

V_{OUT} = 5.0 V

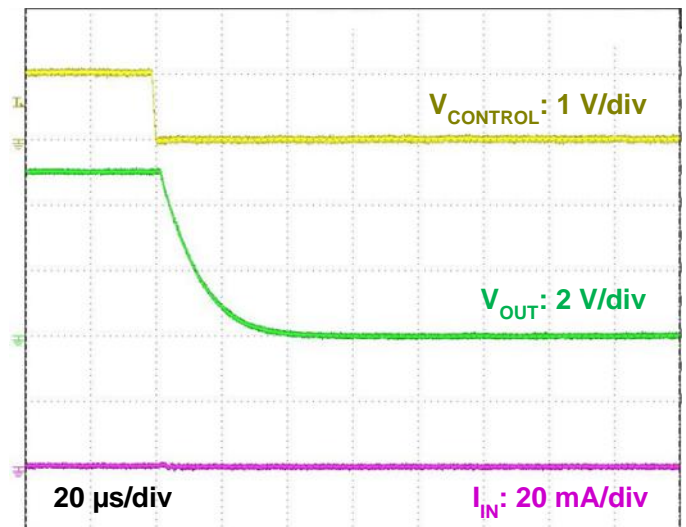
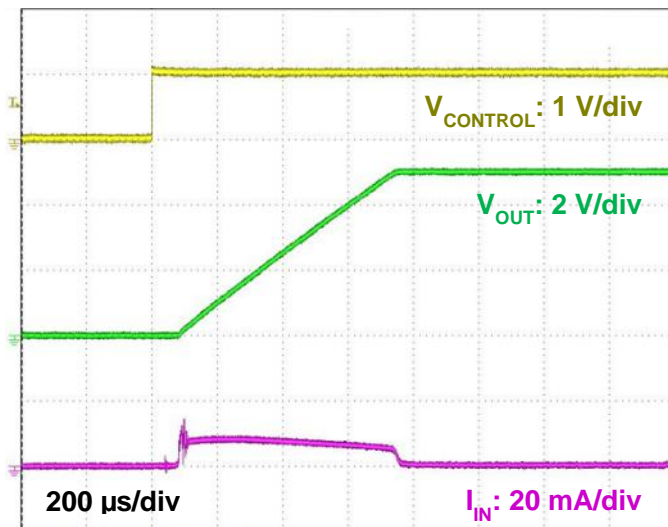

Note: The above characteristics curves are presented for reference only and not guaranteed by production test, unless otherwise noted.

t_{ON} / t_{OFF} Response

(C_{IN} = 1.0 μF, V_{IN} = 2.0 V or V_{OUT} + 0.5 V (whichever is greater), V_{CONTROL} = 0 V ↔ 1.0 V, T_a = 25°C)

- C_{OUT} = 10 μF, I_{OUT} = 0 mA

V_{OUT} = 0.9 V

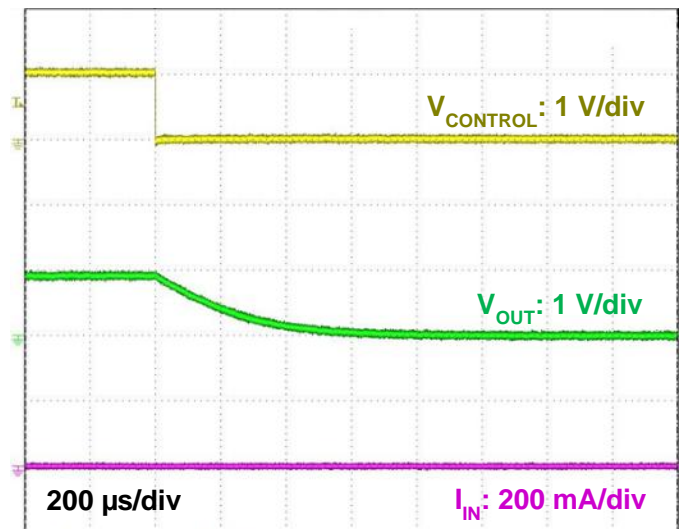
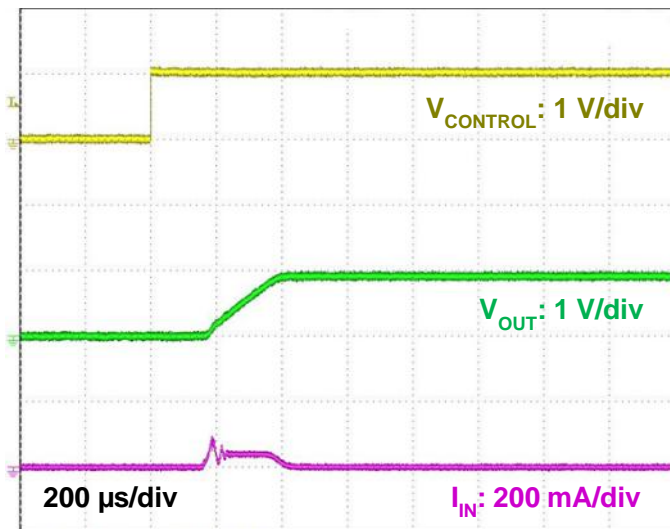

V_{OUT} = 1.8 V

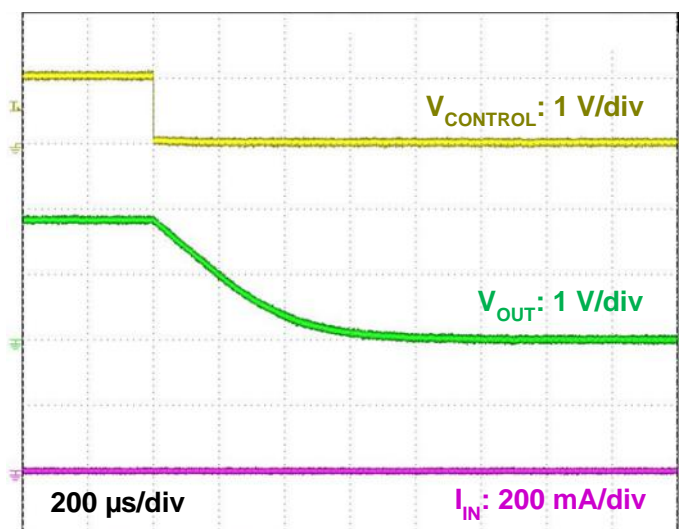
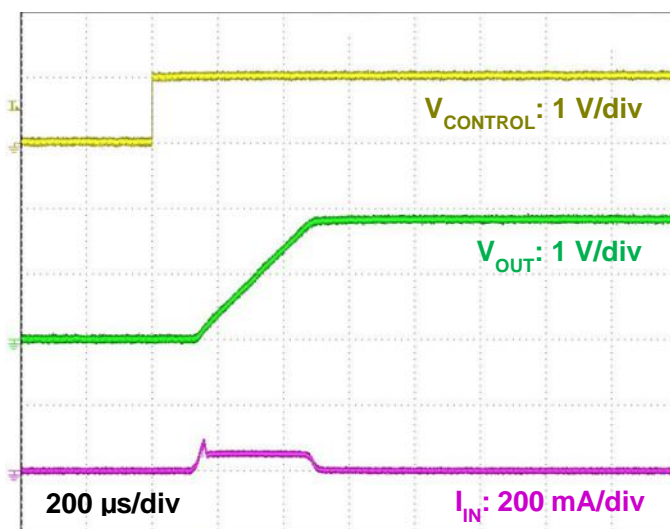

Note: The above characteristics curves are presented for reference only and not guaranteed by production test, unless otherwise noted.

t_{ON} / t_{OFF} Response

(C_{IN} = 1.0 μF, V_{IN} = 2.0 V or V_{OUT} + 0.5 V (whichever is greater), V_{CONTROL} = 0 V ↔ 1.0 V, T_a = 25°C)

- C_{OUT} = 10 μF, I_{OUT} = 0 mA

V_{OUT} = 2.8 V

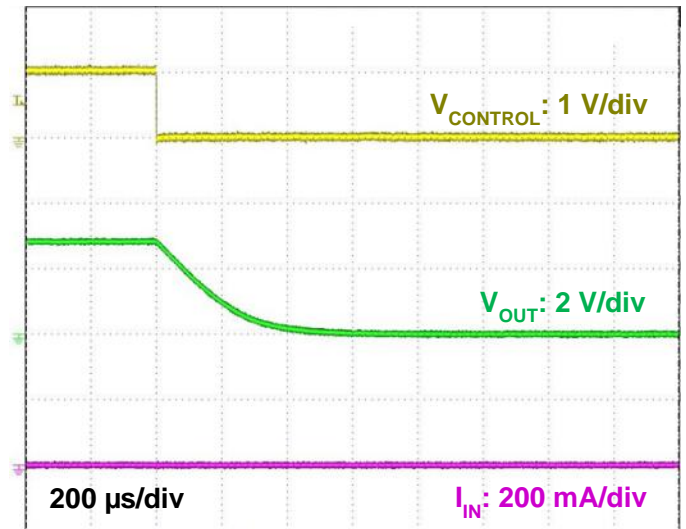
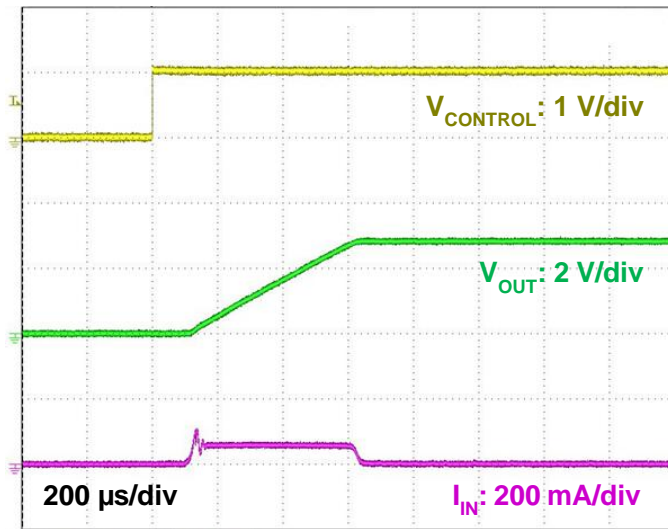

V_{OUT} = 5.0 V

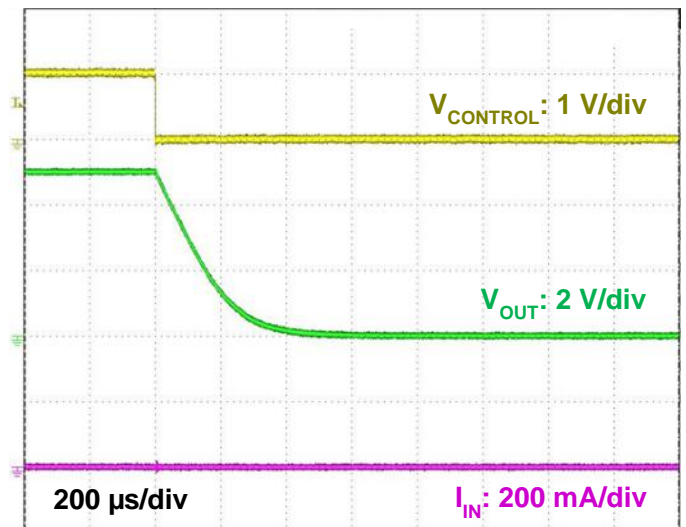
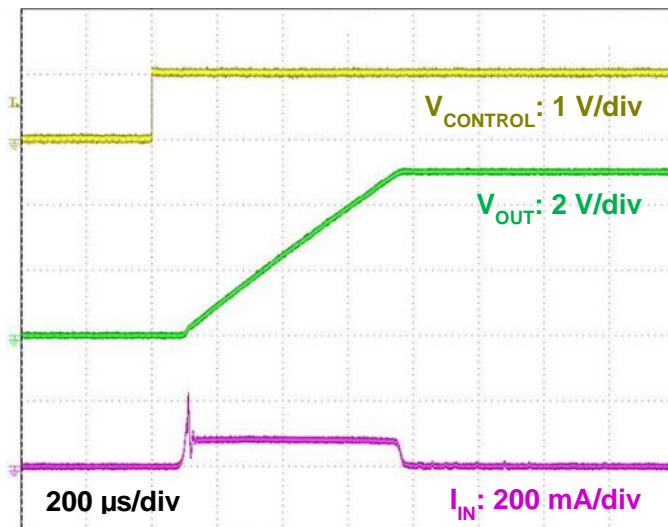

Note: The above characteristics curves are presented for reference only and not guaranteed by production test, unless otherwise noted.

t_{ON} / t_{OFF} Response

($C_{IN} = 1.0 \mu F$, $V_{IN} = 2.0 V$ or $V_{OUT} + 0.5 V$ (whichever is greater), $V_{CONTROL} = 0 V \leftrightarrow 1.0 V$, $T_a = 25^\circ C$)

- $C_{OUT} = 1.0 \mu F$, $I_{OUT} = 500 mA$

$V_{OUT} = 0.9 V$

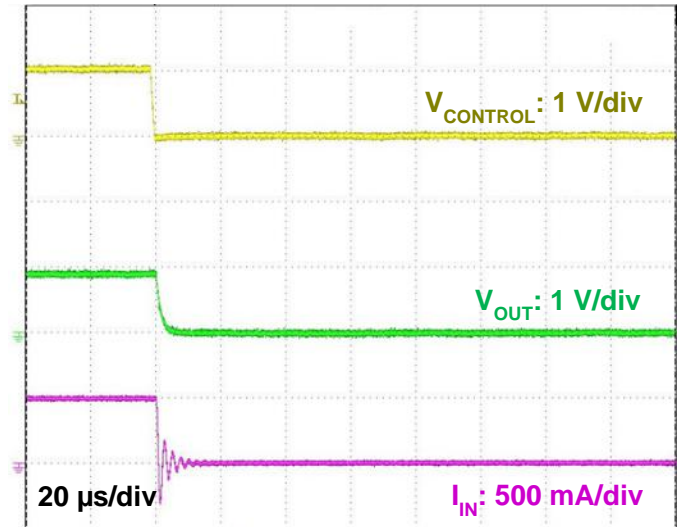
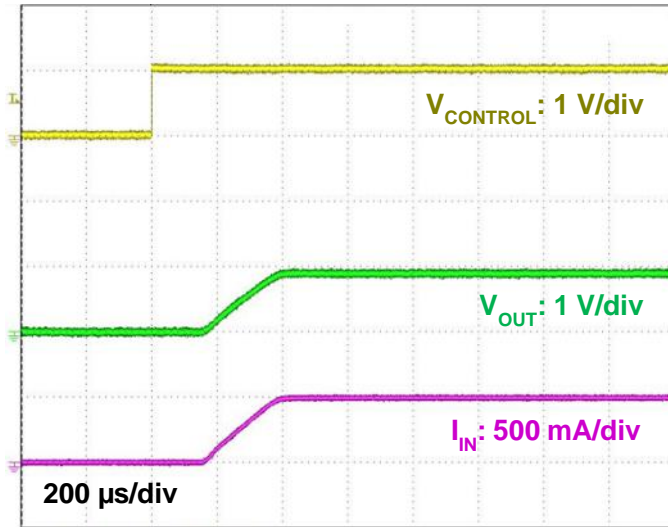

$V_{OUT} = 1.8 V$

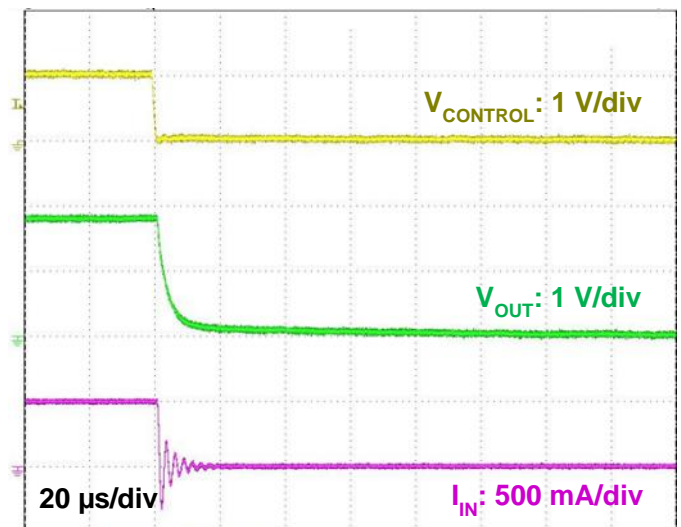
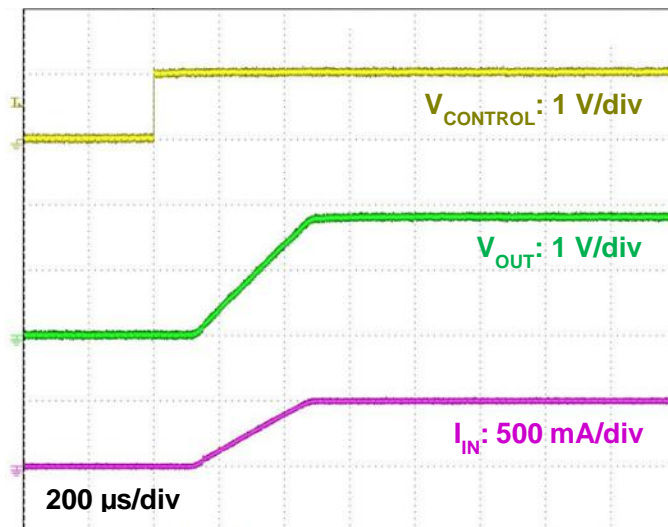

Note: The above characteristics curves are presented for reference only and not guaranteed by production test, unless otherwise noted.

t_{ON} / t_{OFF} Response

(C_{IN} = 1.0 μF, V_{IN} = 2.0 V or V_{OUT} + 0.5 V (whichever is greater), V_{CONTROL} = 0 V ↔ 1.0 V, T_a = 25°C)

- C_{OUT} = 1.0 μF, I_{OUT} = 500 mA

V_{OUT} = 2.8 V

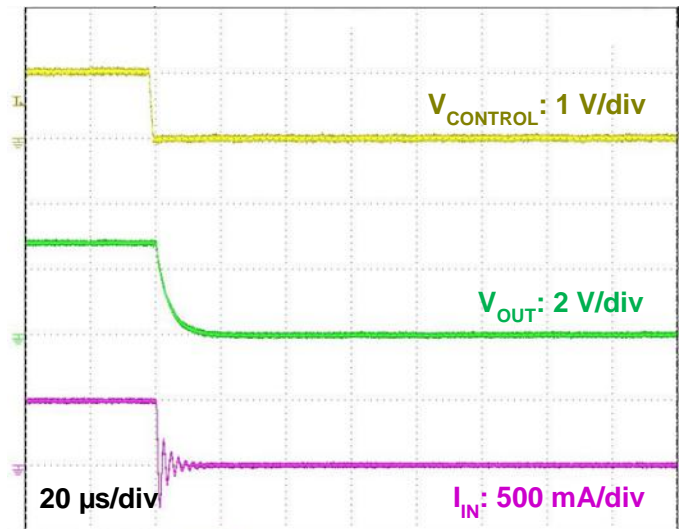
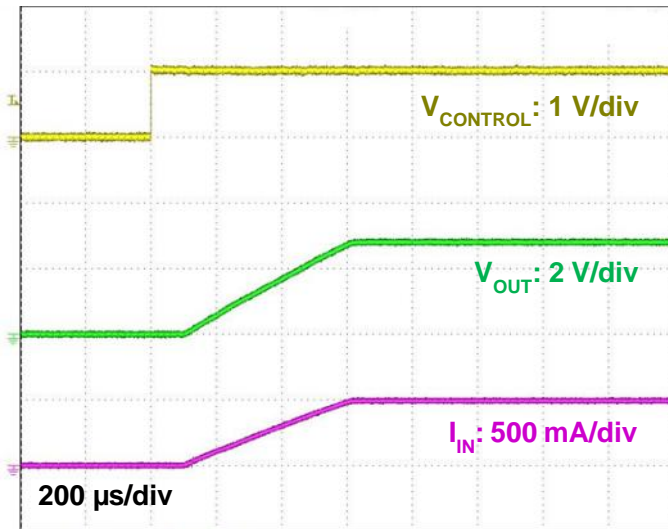

V_{OUT} = 5.0 V

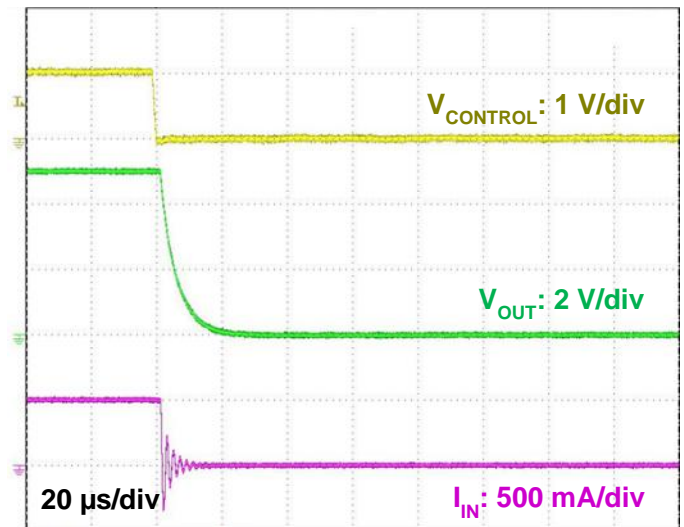
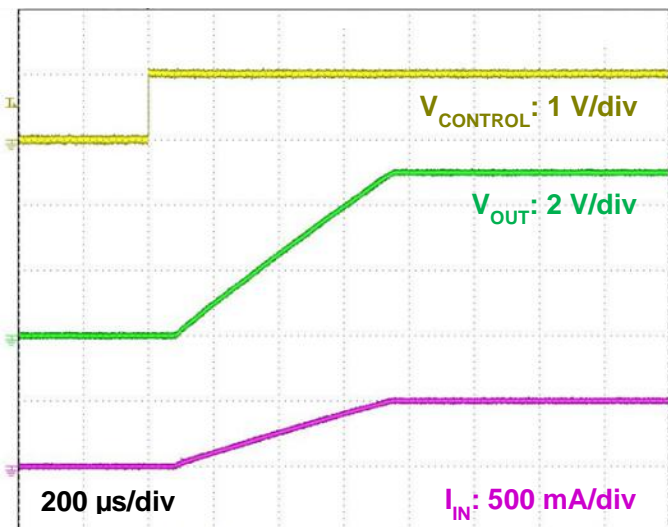

Note: The above characteristics curves are presented for reference only and not guaranteed by production test, unless otherwise noted.

t_{ON} / t_{OFF} Response

(C_{IN} = 1.0 μF, V_{IN} = 2.0 V or V_{OUT} + 0.5 V (whichever is greater), V_{CONTROL} = 0 V ↔ 1.0 V, T_a = 25°C)

- C_{OUT} = 10 μF, I_{OUT} = 500 mA

V_{OUT} = 0.9 V

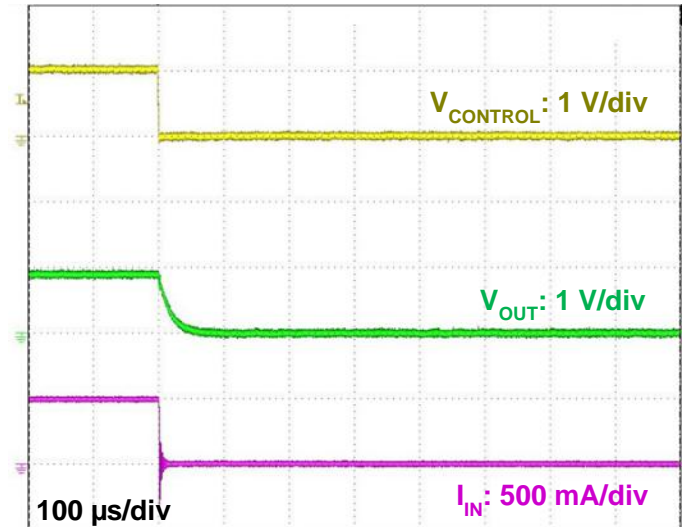
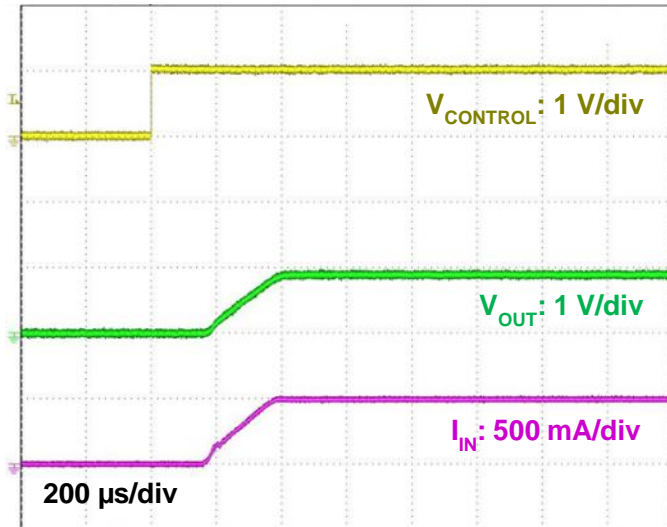

V_{OUT} = 1.8 V

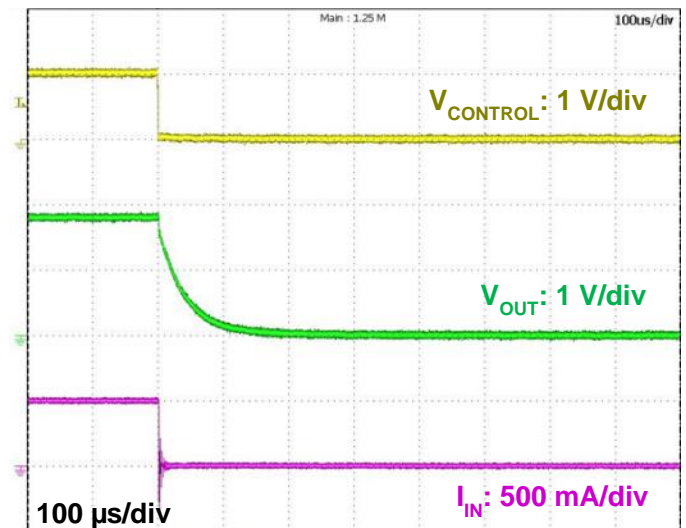
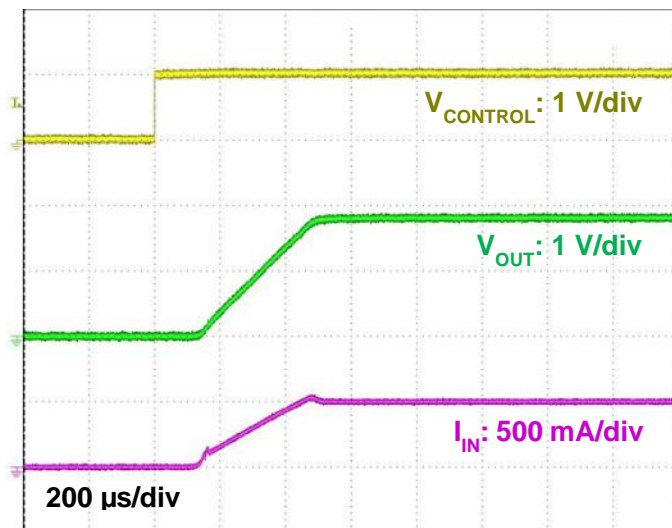

Note: The above characteristics curves are presented for reference only and not guaranteed by production test, unless otherwise noted.

t_{ON} / t_{OFF} Response

($C_{IN} = 1.0 \mu F$, $V_{IN} = 2.0 V$ or $V_{OUT} + 0.5 V$ (whichever is greater), $V_{CONTROL} = 0 V \leftrightarrow 1.0 V$, $T_a = 25^\circ C$)

- $C_{OUT} = 10 \mu F$, $I_{OUT} = 500 mA$

$V_{OUT} = 2.8 V$

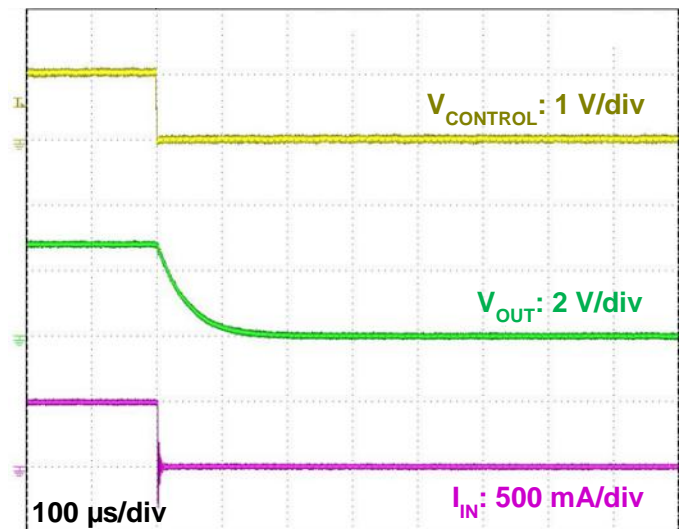
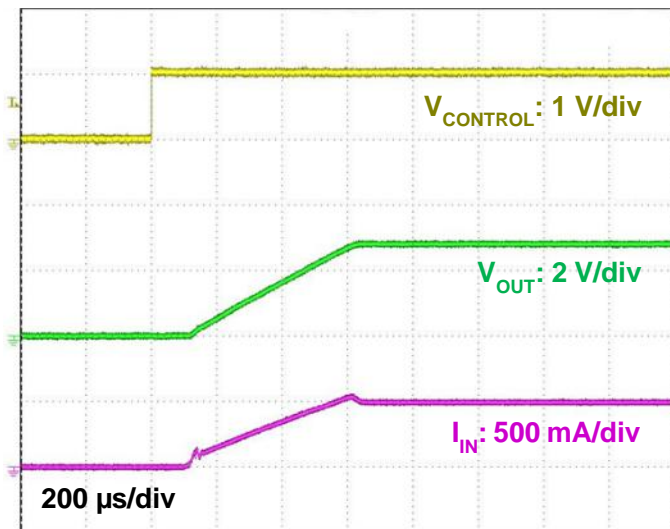

$V_{OUT} = 5.0 V$

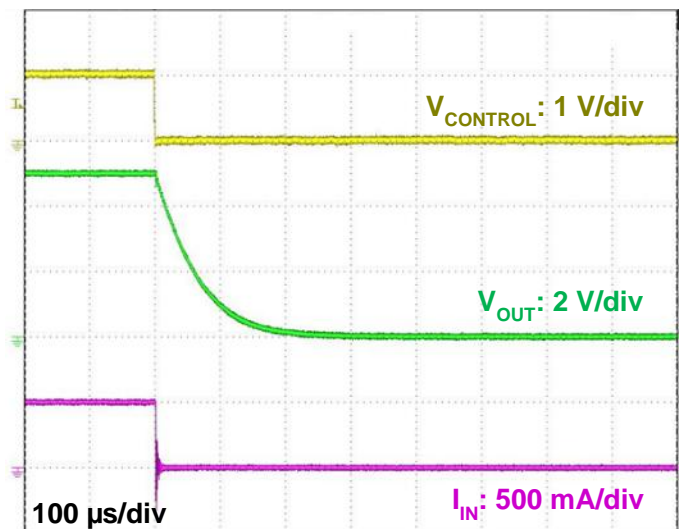
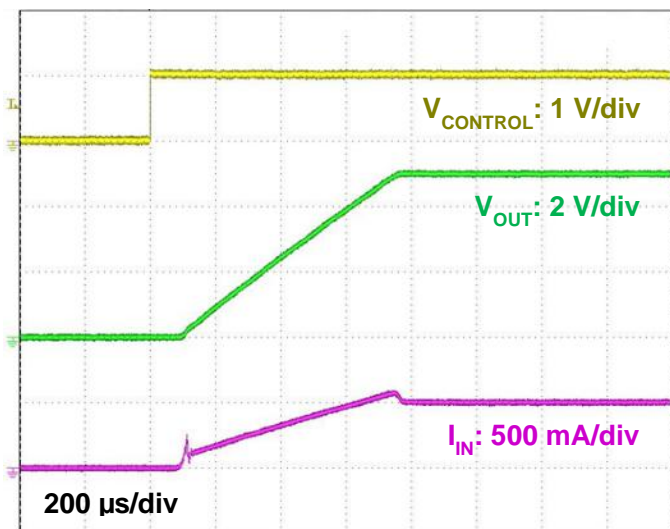

Note: The above characteristics curves are presented for reference only and not guaranteed by production test, unless otherwise noted.

12.9. Load Transient Response

($C_{IN} = 1.0 \mu F$, $C_{OUT} = 1.0 \mu F$, $V_{IN} = 3.3 V$, $V_{OUT} = 2.8 V$, $t_r = 1.0 \mu s$, $t_f = 1.0 \mu s$, $T_a = 25^\circ C$)

$I_{OUT} = 1 mA \leftrightarrow 500 mA$

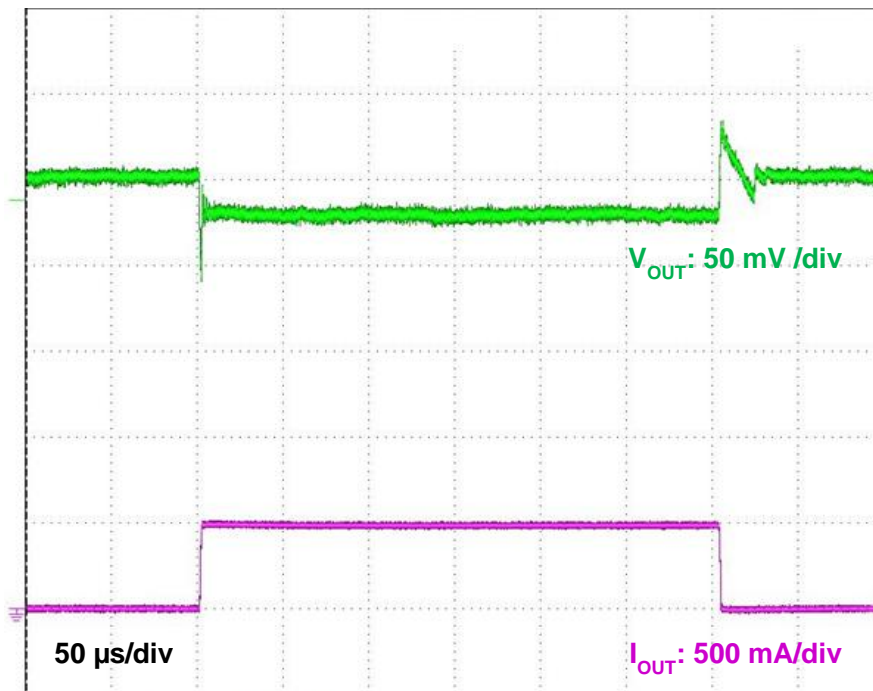

$I_{OUT} = 0 mA \leftrightarrow 100 mA$

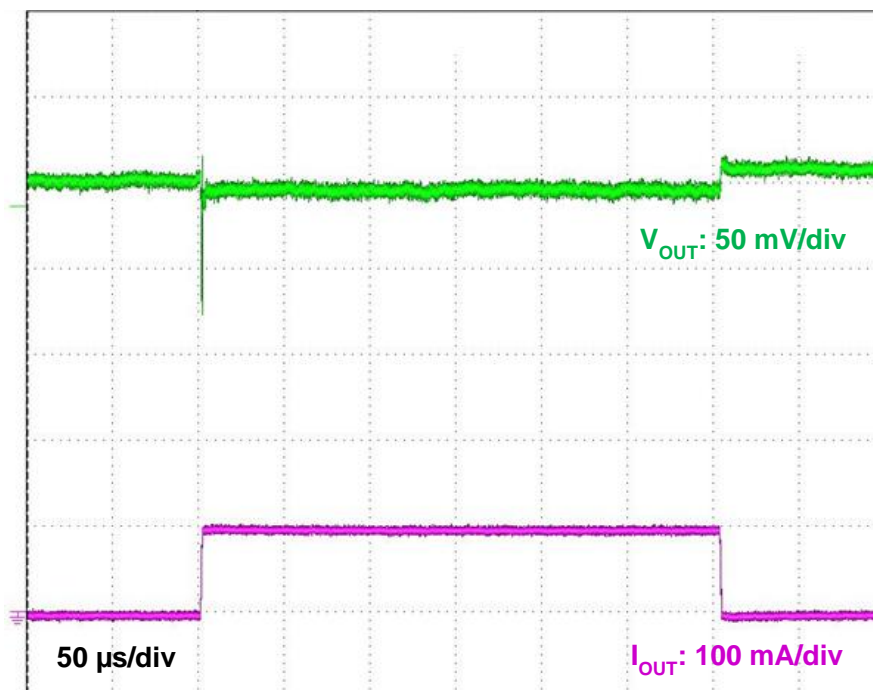

Note: The above characteristics curves are presented for reference only and not guaranteed by production test, unless otherwise noted.

13. Package Information

DFN4D

Unit: mm

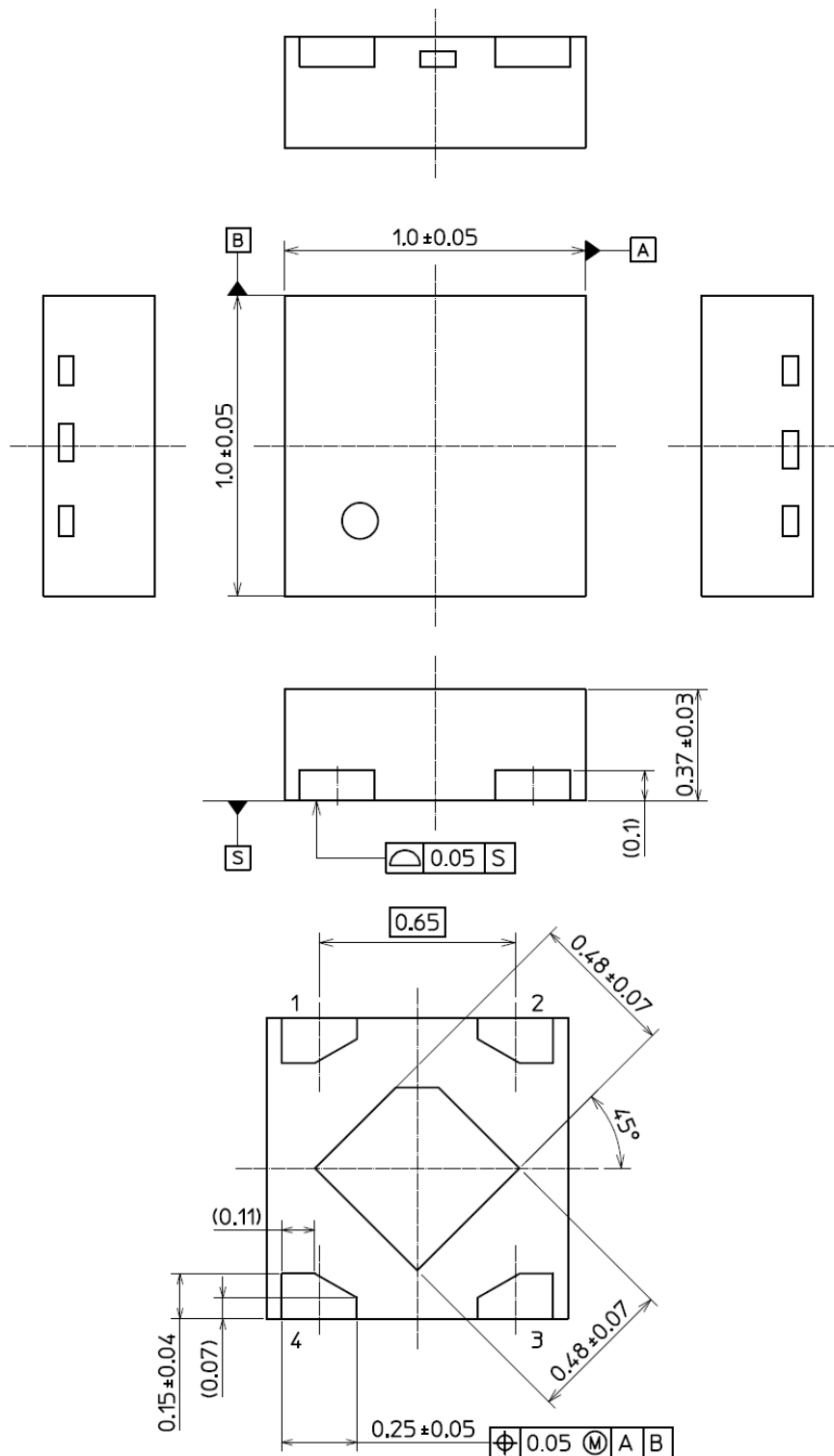

Weight: 1.1 mg (Typ.)

Figure 10.1 Package Dimensions

14. Land pattern Dimensions (for reference only)

Unit: mm

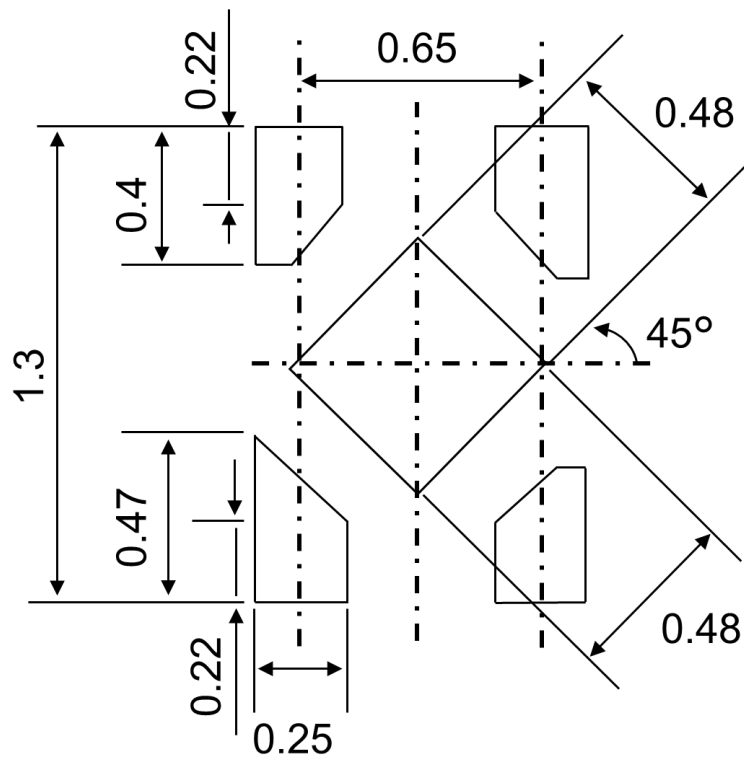

RESTRICTIONS ON PRODUCT USE

Toshiba Corporation and its subsidiaries and affiliates are collectively referred to as "TOSHIBA". Hardware, software and systems described in this document are collectively referred to as "Product".

- TOSHIBA reserves the right to make changes to the information in this document and related Product without notice.
- This document and any information herein may not be reproduced without prior written permission from TOSHIBA. Even with TOSHIBA's written permission, reproduction is permissible only if reproduction is without alteration/omission.
- Though TOSHIBA works continually to improve Product's quality and reliability, Product can malfunction or fail. Customers are responsible for complying with safety standards and for providing adequate designs and safeguards for their hardware, software and systems which minimize risk and avoid situations in which a malfunction or failure of Product could cause loss of human life, bodily injury or damage to property, including data loss or corruption. Before customers use the Product, create designs including the Product, or incorporate the Product into their own applications, customers must also refer to and comply with (a) the latest versions of all relevant TOSHIBA information, including without limitation, this document, the specifications, the data sheets and application notes for Product and the precautions and conditions set forth in the "TOSHIBA Semiconductor Reliability Handbook" and (b) the instructions for the application with which the Product will be used with or for. Customers are solely responsible for all aspects of their own product design or applications, including but not limited to (a) determining the appropriateness of the use of this Product in such design or applications; (b) evaluating and determining the applicability of any information contained in this document, or in charts, diagrams, programs, algorithms, sample application circuits, or any other referenced documents; and (c) validating all operating parameters for such designs and applications. **TOSHIBA ASSUMES NO LIABILITY FOR CUSTOMERS' PRODUCT DESIGN OR APPLICATIONS.**
- **PRODUCT IS NEITHER INTENDED NOR WARRANTED FOR USE IN EQUIPMENTS OR SYSTEMS THAT REQUIRE EXTRAORDINARILY HIGH LEVELS OF QUALITY AND/OR RELIABILITY, AND/OR A MALFUNCTION OR FAILURE OF WHICH MAY CAUSE LOSS OF HUMAN LIFE, BODILY INJURY, SERIOUS PROPERTY DAMAGE AND/OR SERIOUS PUBLIC IMPACT ("UNINTENDED USE").** Except for specific applications as expressly stated in this document, Unintended Use includes, without limitation, equipment used in nuclear facilities, equipment used in the aerospace industry, lifesaving and/or life supporting medical equipment, equipment used for automobiles, trains, ships and other transportation, traffic signaling equipment, equipment used to control combustions or explosions, safety devices, elevators and escalators, and devices related to power plant. **IF YOU USE PRODUCT FOR UNINTENDED USE, TOSHIBA ASSUMES NO LIABILITY FOR PRODUCT.** For details, please contact your TOSHIBA sales representative or contact us via our website.
- Do not disassemble, analyze, reverse-engineer, alter, modify, translate or copy Product, whether in whole or in part.
- Product shall not be used for or incorporated into any products or systems whose manufacture, use, or sale is prohibited under any applicable laws or regulations.
- The information contained herein is presented only as guidance for Product use. No responsibility is assumed by TOSHIBA for any infringement of patents or any other intellectual property rights of third parties that may result from the use of Product. No license to any intellectual property right is granted by this document, whether express or implied, by estoppel or otherwise.
- **ABSENT A WRITTEN SIGNED AGREEMENT, EXCEPT AS PROVIDED IN THE RELEVANT TERMS AND CONDITIONS OF SALE FOR PRODUCT, AND TO THE MAXIMUM EXTENT ALLOWABLE BY LAW, TOSHIBA (1) ASSUMES NO LIABILITY WHATSOEVER, INCLUDING WITHOUT LIMITATION, INDIRECT, CONSEQUENTIAL, SPECIAL, OR INCIDENTAL DAMAGES OR LOSS, INCLUDING WITHOUT LIMITATION, LOSS OF PROFITS, LOSS OF OPPORTUNITIES, BUSINESS INTERRUPTION AND LOSS OF DATA, AND (2) DISCLAIMS ANY AND ALL EXPRESS OR IMPLIED WARRANTIES AND CONDITIONS RELATED TO SALE, USE OF PRODUCT, OR INFORMATION, INCLUDING WARRANTIES OR CONDITIONS OF MERCHANTABILITY, FITNESS FOR A PARTICULAR PURPOSE, ACCURACY OF INFORMATION, OR NONINFRINGEMENT.**
- Do not use or otherwise make available Product or related software or technology for any military purposes, including without limitation, for the design, development, use, stockpiling or manufacturing of nuclear, chemical, or biological weapons or missile technology products (mass destruction weapons). Product and related software and technology may be controlled under the applicable export laws and regulations including, without limitation, the Japanese Foreign Exchange and Foreign Trade Law and the U.S. Export Administration Regulations. Export and re-export of Product or related software or technology are strictly prohibited except in compliance with all applicable export laws and regulations.
- Please contact your TOSHIBA sales representative for details as to environmental matters such as the RoHS compatibility of Product. Please use Product in compliance with all applicable laws and regulations that regulate the inclusion or use of controlled substances, including without limitation, the EU RoHS Directive. **TOSHIBA ASSUMES NO LIABILITY FOR DAMAGES OR LOSSES OCCURRING AS A RESULT OF NONCOMPLIANCE WITH APPLICABLE LAWS AND REGULATIONS.**