

Introduction of Toshiba Zener Diode for protection

Toshiba has wide line-up of Zener diodes to protect device from Electro static discharge (ESD) and overvoltage surge. This is suitable for consumer equipment, IoT device, Robotics, FA, Industrial equipment.

Countermeasure of overvoltage surge for circuit design

There are many surges around us. Various surges are generated in electronic circuit, and some case it may need to protect from such a surge. ESD from connector of internal PCB is typical, but also there are an overvoltage surge from inductive loads.

We offers wide line-up of protection products to suppress from such a ESD and surge. We would like to introduce a protection zener diode to protect from various type of overvoltage surge.

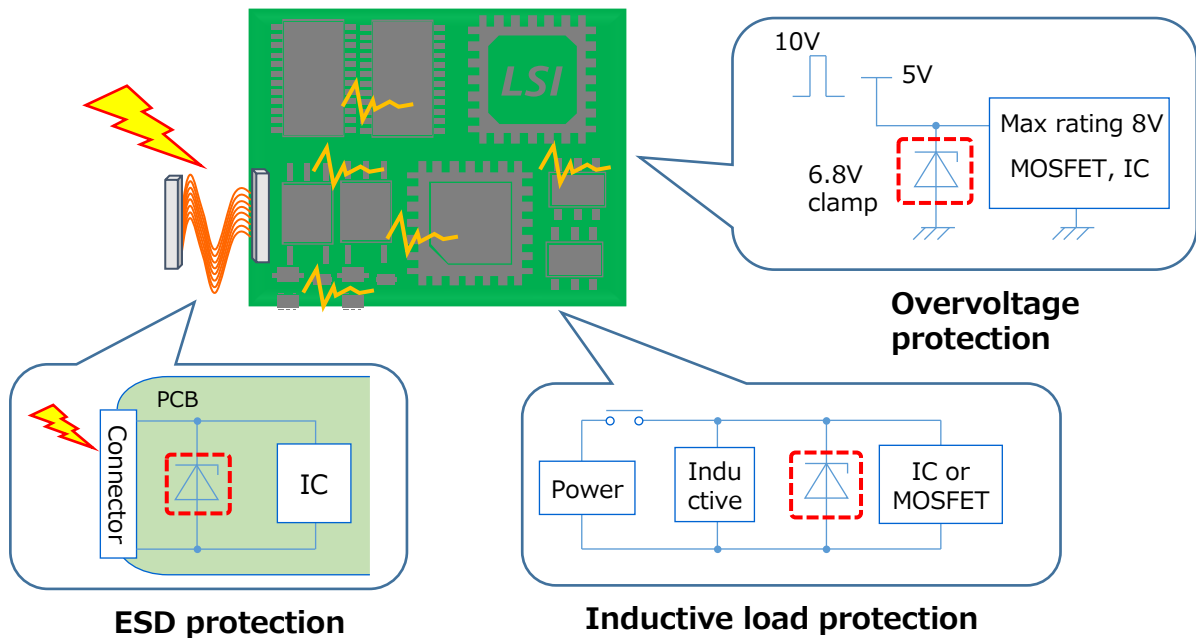

Protective performance of Zener diode

Zener diode provides protection not only from transients with a duration on the order of nanoseconds and microseconds such as ESD events, but also millisecond-order and even near-DC transients such as switching surges that are difficult to absorb with TVS (ESD protection) diodes.

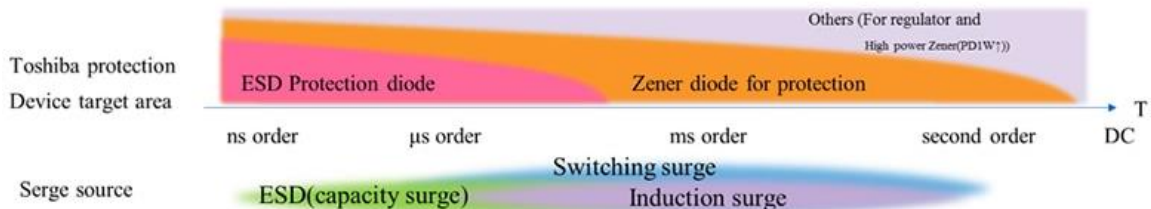

TOSHIBA

Overvoltage protection of power supply line

This figure shows example to absorb an overvoltage surge assuming a hot-plug by using zener diode as reference. It is possible to suppress overvoltage of power supply line by using zener diode.

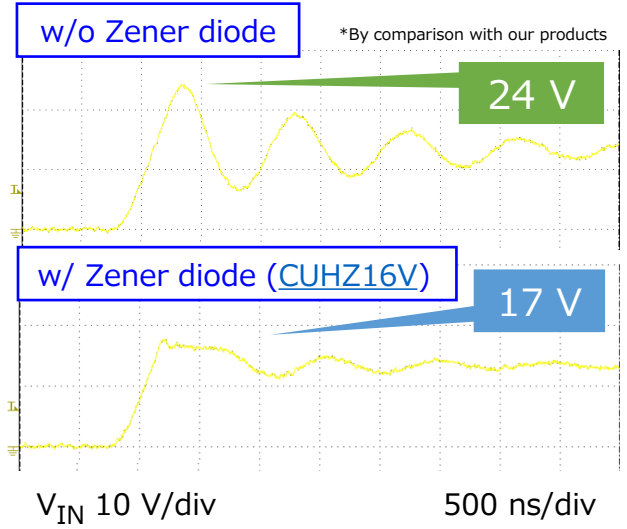
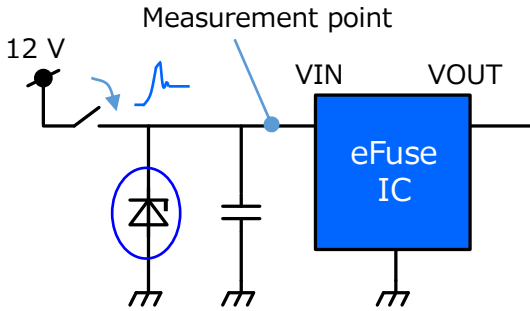

Voltage line-up

Introduce voltage line-up using MKZ series that is small size package using SOT23 (SOT-23) as example. We have wide line-up of voltage rank to support various power supply line.







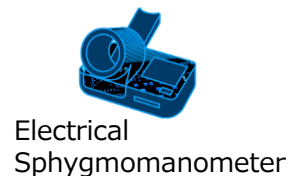
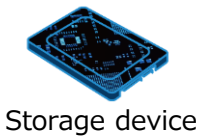

































































































Vz(typ.) (V)	Product Name (MKZ series)	Assumed voltage line	Vz(typ.) (V)	Product Name (MKZ series)	Assumed voltage line
5.6V	MKZ5V6	3V以下	15V	MKZ15V	12Vライン
6.2V	MKZ6V2	3.3Vライン	16V	MKZ16V	12Vライン
6.8V	MKZ6V8	5Vライン	18V	MKZ18V	15Vライン
7.5V	MKZ7V5	5Vライン	20V	MKZ20V	16Vライン
8.2V	MKZ8V2	5Vライン	22V	MKZ22V	20Vライン
9.1V	MKZ9V1	5Vライン	24V	MKZ24V	20Vライン
10V	MKZ10V	9Vライン	27V	MKZ27V	24Vライン
11V	MKZ11V	9Vライン	30V	MKZ30V	24Vライン
12V	MKZ12V	9Vライン	33V	MKZ33V	30Vライン
13V	MKZ13V	12Vライン	36V	MKZ36V	32Vライン

Application (example)

Zener diodes can be used various application, below shows typical examples. Click the icon to see other Toshiba semiconductor products and circuit examples.



































•Toshiba Zener Diode product list (1)

Package	<u>CEZ series</u>	<u>CUZ series</u>	<u>MUZ series</u>	<u>MSZ series</u>	<u>MKZ series</u>
	ESC  1.6×0.8mm 150mW *1	USC  2.5×1.25mm 200mW *1	USM  2.0×2.1mm 150mW *2	S-Mini  2.9×2.5mm 200mW	SOT23  2.9×2.4mm 320mW *3
V _Z 5.6V	CEZ5V6 	CUZ5V6 	MUZ5V6 	MSZ5V6 	MKZ5V6 
(typ.)6.2V	CEZ6V2 	CUZ6V2 	MUZ6V2 	MSZ6V2 	MKZ6V2 
6.8V	CEZ6V8 	CUZ6V8 	MUZ6V8 	MSZ6V8 	MKZ6V8 
7.5V	CEZ7V5 	CUZ7V5 	MUZ7V5 	MSZ7V5 	MKZ7V5 
8.2V	CEZ8V2 	CUZ8V2 	MUZ8V2 	MSZ8V2 	MKZ8V2 
9.1V	CEZ9V1 	CUZ9V1 	MUZ9V1 	MSZ9V1 	MKZ9V1 
10V	CEZ10V 	CUZ10V 	MUZ10V 	MSZ10V 	MKZ10V 
11V	CEZ11V 	CUZ11V 	MUZ11V 	MSZ11V 	MKZ11V 
12V	CEZ12V 	CUZ12V 	MUZ12V 	MSZ12V 	MKZ12V 
13V	CEZ13V 	CUZ13V 	MUZ13V 	MSZ13V 	MKZ13V 
15V	CEZ15V 	CUZ15V 	MUZ15V 	MSZ15V 	MKZ15V 
16V	CEZ16V 	CUZ16V 	MUZ16V 	MSZ16V 	MKZ16V 
18V	CEZ18V 	CUZ18V 	MUZ18V 	MSZ18V 	MKZ18V 
20V	CEZ20V 	CUZ20V 	MUZ20V 	MSZ20V 	MKZ20V 
22V	CEZ22V 	CUZ22V 	MUZ22V 	MSZ22V 	MKZ22V 
24V	CEZ24V 	CUZ24V 	MUZ24V 	MSZ24V 	MKZ24V 
27V	CEZ27V 	CUZ27V 	MUZ27V 	MSZ27V 	MKZ27V 
30V	CEZ30V 	CUZ30V 	MUZ30V 	MSZ30V 	MKZ30V 
33V	CEZ33V 	CUZ33V 	MUZ33V 	MSZ33V 	MKZ33V 
36V	CEZ36V 	CUZ36V 	MUZ36V 	MSZ36V 	MKZ36V 

*1: mounted on FR4 PCB(20x20mm, Cu pad 4x4mm)
 *2: mounted on FR4 PCB(20x20mm, Cu pad 0.5mm² x3)
 *3: mounted on FR4 PCB(25.4x25.4mm, Cu pad 0.42mm² x3)





•Toshiba Zener Diode product list (2)

	CUHZ series US2H 	CRY,Z series S-FLAT 	CSLZ series SL2 
Package	2.5×1.4mm	3.5×1.6mm	0.62×0.32mm
Power Dissipation	1200mW *4	700mW *5	150mW *1
V _Z (typ.)	5.6V CUHZ5V6 	-	CSLZ5V6 
6.2V	CUHZ6V2 	CRY62 	CSLZ6V2 
6.8V	CUHZ6V8 	CRY68 	CSLZ6V8 
8.2V	CUHZ8V2 	CRY82 	CSLZ8V2 
10V	-	CRZ10 	CSLZ10V 
12V	CUHZ12V 	CRZ12 	CSLZ12V 
16V	CUHZ16V 	CRZ16 	CSLZ16V 
20V	CUHZ20V 	CRZ20 	CSLZ20V 
24V	CUHZ24V 	CRZ24 	CSLZ24V 
30V	CUHZ30V 	CRZ30 	CSLZ30V 
36V	CUHZ36V 	CRZ36 	-

*4: mounted on FR4 PCB(25.4x25.4mm, Cu pad 645 mm²)
 *5: mounted on FR4 PCB(50x50mm, Cu pad 6x6 mm)

** Company names, product names, and service names may be trademarks of their respective companies.

LINKS

- [Product page](#) 
- [Application Notes](#) :
 - Basics of ESD Protection (TVS) Diodes 
 - Overvoltage protection device Zener diode and ESD protection diode 
- [Frequently Asked Questions \(FAQ\) of diodes](#) 
- [Online distributor purchase, inventory](#) 

RESTRICTIONS ON PRODUCT USE

Toshiba Corporation and its subsidiaries and affiliates are collectively referred to as "TOSHIBA".

Hardware, software and systems described in this document are collectively referred to as "Product".

- TOSHIBA reserves the right to make changes to the information in this document and related Product without notice.
- This document and any information herein may not be reproduced without prior written permission from TOSHIBA. Even with TOSHIBA's written permission, reproduction is permissible only if reproduction is without alteration/omission.
- Though TOSHIBA works continually to improve Product's quality and reliability, Product can malfunction or fail. Customers are responsible for complying with safety standards and for providing adequate designs and safeguards for their hardware, software and systems which minimize risk and avoid situations in which a malfunction or failure of Product could cause loss of human life, bodily injury or damage to property, including data loss or corruption. Before customers use the Product, create designs including the Product, or incorporate the Product into their own applications, customers must also refer to and comply with (a) the latest versions of all relevant TOSHIBA information, including without limitation, this document, the specifications, the data sheets and application notes for Product and the precautions and conditions set forth in the "TOSHIBA Semiconductor Reliability Handbook" and (b) the instructions for the application with which the Product will be used with or for. Customers are solely responsible for all aspects of their own product design or applications, including but not limited to (a) determining the appropriateness of the use of this Product in such design or applications; (b) evaluating and determining the applicability of any information contained in this document, or in charts, diagrams, programs, algorithms, sample application circuits, or any other referenced documents; and (c) validating all operating parameters for such designs and applications. TOSHIBA ASSUMES NO LIABILITY FOR CUSTOMERS' PRODUCT DESIGN OR APPLICATIONS.
- PRODUCT IS NEITHER INTENDED NOR WARRANTED FOR USE IN EQUIPMENTS OR SYSTEMS THAT REQUIRE EXTRAORDINARILY HIGH LEVELS OF QUALITY AND/OR RELIABILITY, AND/OR A MALFUNCTION OR FAILURE OF WHICH MAY CAUSE LOSS OF HUMAN LIFE, BODILY INJURY, SERIOUS PROPERTY DAMAGE AND/OR SERIOUS PUBLIC IMPACT ("UNINTENDED USE"). Except for specific applications as expressly stated in this document, Unintended Use includes, without limitation, equipment used in nuclear facilities, equipment used in the aerospace industry, lifesaving and/or life supporting medical equipment, equipment used for automobiles, trains, ships and other transportation, traffic signaling equipment, equipment used to control combustions or explosions, safety devices, elevators and escalators, and devices related to power plant. IF YOU USE PRODUCT FOR UNINTENDED USE, TOSHIBA ASSUMES NO LIABILITY FOR PRODUCT. For details, please contact your TOSHIBA sales representative or contact us via our website.
- Do not disassemble, analyze, reverse-engineer, alter, modify, translate or copy Product, whether in whole or in part.
- Product shall not be used for or incorporated into any products or systems whose manufacture, use, or sale is prohibited under any applicable laws or regulations.
- The information contained herein is presented only as guidance for Product use. No responsibility is assumed by TOSHIBA for any infringement of patents or any other intellectual property rights of third parties that may result from the use of Product. No license to any intellectual property right is granted by this document, whether express or implied, by estoppel or otherwise.
- ABSENT A WRITTEN SIGNED AGREEMENT, EXCEPT AS PROVIDED IN THE RELEVANT TERMS AND CONDITIONS OF SALE FOR PRODUCT, AND TO THE MAXIMUM EXTENT ALLOWABLE BY LAW, TOSHIBA (1) ASSUMES NO LIABILITY WHATSOEVER, INCLUDING WITHOUT LIMITATION, INDIRECT, CONSEQUENTIAL, SPECIAL, OR INCIDENTAL DAMAGES OR LOSS, INCLUDING WITHOUT LIMITATION, LOSS OF PROFITS, LOSS OF OPPORTUNITIES, BUSINESS INTERRUPTION AND LOSS OF DATA, AND (2) DISCLAIMS ANY AND ALL EXPRESS OR IMPLIED WARRANTIES AND CONDITIONS RELATED TO SALE, USE OF PRODUCT, OR INFORMATION, INCLUDING WARRANTIES OR CONDITIONS OF MERCHANTABILITY, FITNESS FOR A PARTICULAR PURPOSE, ACCURACY OF INFORMATION, OR NONINFRINGEMENT.
- Do not use or otherwise make available Product or related software or technology for any military purposes, including without limitation, for the design, development, use, stockpiling or manufacturing of nuclear, chemical, or biological weapons or missile technology products (mass destruction weapons). Product and related software and technology may be controlled under the applicable export laws and regulations including, without limitation, the Japanese Foreign Exchange and Foreign Trade Law and the U.S. Export Administration Regulations. Export and re-export of Product or related software or technology are strictly prohibited except in compliance with all applicable export laws and regulations.
- Please contact your TOSHIBA sales representative for details as to environmental matters such as the RoHS compatibility of Product. Please use Product in compliance with all applicable laws and regulations that regulate the inclusion or use of controlled substances, including without limitation, the EU RoHS Directive. TOSHIBA ASSUMES NO LIABILITY FOR DAMAGES OR LOSSES OCCURRING AS A RESULT OF NONCOMPLIANCE WITH APPLICABLE LAWS AND REGULATIONS.

Toshiba Electronic Devices & Storage Corporation

<https://toshiba.semicon-storage.com/>