

Basics of Diodes

(Absolute Maximum Ratings and Electrical Characteristics)

Outline:

Diodes are used in a wide range of equipment for various applications such as rectification, reverse-current blocking, and circuit protection. In addition to silicon (Si) pn diodes, various types of diodes are available, including Schottky barrier diodes (SBDs), transient voltage suppressor (TVS) diodes (also known as ESD protection diodes), and Zener diodes. Toshiba's product portfolio also includes state-of-the-art silicon carbide (SiC) SBDs fabricated using a compound semiconductor. This application note discusses the absolute maximum ratings and electrical characteristics of these diodes.

Table of Contents

Outline:.....	1
Table of Contents	2
1. Maximum ratings.....	5
1.1. Significance of maximum ratings	5
1.2. Maximum ratings common to all diodes.....	5
1.2.1. Junction temperature (T_j).....	5
1.2.2. Power dissipation (P_D , P)	6
1.2.3. Storage temperature (T_{stg})	7
1.2.4. Isolation voltage ($V_{ISO(RMS)}$ or V_{dis}).....	8
1.2.5. Mounting torque, TOR.....	8
1.3. Maximum ratings common to switching diodes, rectifier diodes, Si Schottky barrier diodes (SBDs), and SiC SBDs.....	9
1.3.1. Voltage ratings.....	9
1.3.2. Current ratings.....	10
1.4. Ratings common to TVS (ESD protection) and Zener diodes.....	13
1.4.1. Electrostatic discharge voltage (IEC 61000-4-2) (contact), V_{ESD}	13
1.4.2. Electrostatic discharge voltage (IEC 61000-4-2) (air), V_{ESD}	13
1.4.3. Peak pulse power ($t_p = 8/20 \mu s$), P_{PK}	14
1.4.4. Peak pulse current ($t_p = 8/20 \mu s$), I_{pp}	14
2. Electrical characteristics.....	15
2.1. Electrical characteristics common to switching diodes, rectifier diodes, Si SBDs, and SiC SBDs.....	15
2.1.1. Forward voltage (V_F) and peak forward voltage (V_{FM}).....	15
2.1.2. Reverse current (I_R) and peak repetitive reverse current (I_{RRM})	16
2.1.3. Total capacitance (C_t) and junction capacitance (C_j).....	16
2.1.4. Total capacitive charge (Q_{Cj})	17
2.1.5. Forward recovery time (t_{fr})	17
2.1.6. Reverse recovery time (t_{rr})	17
2.2. Electrical characteristics common to TVS (ESD protection) and Zener diodes	20
2.2.1. Working peak reverse voltage, V_{RWM} (TVS diodes)	20
2.2.2. Reverse breakdown voltage, V_{BR} (TVS diodes).....	20

2.2.3. Clamp voltage, V_C (TVS diodes).....	21
2.2.4. Zener voltage, V_Z (Zener diodes).....	21
2.2.5. Forward voltage, V_F (Zener diodes)	21
2.2.6. Reverse current, I_R (TVS and Zener diodes)	21
2.2.7. Dynamic resistance, R_{DYN} (TVS and Zener diodes)	21
2.2.8. Dynamic resistance, Z_Z or r_d (Zener diodes)	22
2.2.9. Temperature coefficient, α_T (Zener diodes)	22
2.2.10. Total capacitance, C_t (TVS and Zener diodes)	23
RESTRICTIONS ON PRODUCT USE	25

List of Figures

Figure 1.1 Definitions of voltage ratings.....	9
Figure 1.2 Definitions of steady-state current ratings.....	11
Figure 1.3 Definitions of instantaneous pulse current ratings	12
Figure 1.4 Example of an IEC 61000-4-2 test circuit.....	13
Figure 1.5 Example of an IEC 61000-4-2 test waveform	13
Figure 1.6 Example of an IEC 61000-4-5 test circuit.....	14
Figure 1.7 Example of an IEC 61000-4-5 test waveform	14
Figure 2.1 Examples of forward current-vs-forward voltage curves of Si and SiC SBDs	15
Figure 2.2 Example of a test circuit for forward recovery time (t_{fr}).....	17
Figure 2.3 Example of a waveform showing forward recovery time (t_{fr}).....	17
Figure 2.4 Example of a test circuit for reverse recovery time (t_{rr}).....	18
Figure 2.5 Example of a waveform showing reverse recovery time (t_{rr}).....	18
Figure 2.6 Reverse recovery operation	18
Figure 2.7 Example of a waveform of a high- efficiency diode (HED) during t_{rr}	19
Figure 2.8 Example of a waveform of a super-fast- recovery diode (S-FRD) during t_{rr}	19
Figure 2.9 Example of a waveform of a general- purpose diode during t_{rr}	19
Figure 2.10 Example of an SBD recovery waveform.....	20
Figure 2.11 Example of an HED recovery waveform.....	20
Figure 2-12 Definitions of electrical characteristics	20
Figure 2.13 Example of a TLP test	22
Figure 2.14 $Z_z (r_d)$ of a Zener diode	22
Figure 2.15 Definition of the temperature coefficient (α_T)	23

List of Tables

Table 1-1 Maximum mounting torque for through-hole diodes	8
---	---

1. Maximum ratings

1.1. Significance of maximum ratings

For diodes, the maximum allowable current, reverse voltage, power dissipation, and other characteristics are specified as maximum ratings.

In circuit design using semiconductors, understanding maximum ratings is very important in order to obtain the best performance from diodes and maintain device reliability throughout the target operating life.

The electrical characteristics of semiconductor devices are very sensitive to temperature. Therefore, the maximum ratings are determined, considering the change in characteristics brought about by temperature rise.

For example, if junction temperature exceeds the specified junction temperature while a diode is reverse-biased, its reverse current increases. An increase in reverse current causes reverse power dissipation to increase. This, in turn, causes a rise in junction temperature, which leads to an increase in reverse current, entering a vicious circle. Semiconductors might be destroyed by this vicious circle. In order to guarantee the product life and reliability of devices, absolute maximum ratings must not be exceeded even instantaneously. Maximum rated values are determined by materials, chip size, package, device design, and manufacturing conditions.

The absolute maximum ratings are the highest values that must not be exceeded during operation even instantaneously. When two or more ratings are specified, two ratings cannot be applied to the diode at the same time.

For diodes, the maximum ratings in datasheets, etc. are the absolute maximum ratings.

They are specified at an ambient temperature of 25°C unless otherwise specified.

1.2. Maximum ratings common to all diodes

The table of the rating shown below is an example of Toshiba.

1.2.1. Junction temperature (T_j)

The materials of a diode and their reliability determine the junction temperature, T_j . The junction temperature, T_j , must be considered not only in terms of the functional operation of the diode but also in terms of its reliability such as device degradation and product life. Generally, degradation of the diode accelerates as the junction temperature increases. The average life in hours of operation, L_m , and the junction temperature in Kelvin (K), T_j , have the equation relationship shown below. Here, A and B are element-specific constants.

Characteristic	Symbol	Rating	Unit
Junction temperature	T_j	150	°C

$$\ln L_m \approx A + \frac{B}{T_j} \dots\dots\dots (1-1)$$

- L_m : Average life (time)
- A : Device-specific constant
- B : Device-specific constant
- T_j : Junction temperature (in Kelvin) (K)

Therefore, the junction temperature rating is determined in such a manner as to achieve the target product life. Also, reverse current is dependent on temperature as follows:

$$\ln I_R \approx A \cdot \left(-\frac{q \cdot V}{2 \cdot K \cdot T_j} \right) \dots\dots\dots (1-2)$$

- A : Device-specific constant
- q : Electron charge (1.602×10⁻¹⁹) (C)
- K : Boltzmann constant (1.381×10⁻²³) (J·K⁻¹)
- T_j : Junction temperature (in Kelvin) (K)
- V : Biased voltage (V)

As can be seen from Equation 1-2, a diode exhibits a large reverse current at high temperature, causing large power dissipation. Because of this, typical silicon (Si) diodes could enter a vicious circle—a rise in junction temperature → an increase in reverse current → an increase in power dissipation → a rise in junction temperature—leading to thermal runaway.

To prevent thermal runaway, it is necessary to carefully consider junction temperature and heat dissipation conditions.

1.2.2. Power dissipation (P_D, P)

Power dissipation (P_D, P) is the maximum power that can be continuously dissipated under the specified heat dissipation conditions. The allowable power dissipation of a diode varies with the conditions under which it is used (such as the type and size of the board on which the diode is mounted, ambient temperature, and heat dissipation conditions). P_D at a case temperature (T_C) of 25°C is calculated as the maximum power dissipation for a diode with an infinite heatsink at an ambient temperature of 25 °C.

Characteristic	Symbol	Rating	Unit
Power dissipation	P _D	1	W

Suppose that a surface-mount diode or a through-hole diode that cannot be attached to a heatsink operates in a steady state at a T_a of 25 °C and maintains steady junction temperature. Then, its power dissipation can be calculated as follows:

$$P_D = \frac{T_j - 25 \text{ } ^\circ\text{C}}{R_{th(j-a)}} \dots\dots\dots (1-3)$$

- P_D : Power dissipation (W)
- T_j : Junction temperature ($^\circ\text{C}$)
- $R_{th(j-a)}$: Junction-to-ambient thermal resistance ($^\circ\text{C}/\text{W}$)

The transient power dissipation (P_{DP}) is calculated using the transient thermal impedance value shown in individual diode datasheets:

$$P_{DP} = \frac{T_j - 25 \text{ } ^\circ\text{C}}{r_{th(j-a)(t)}} \dots\dots\dots (1-4)$$

- $r_{th(j-a)(t)}$: Junction-to-ambient thermal impedance at a pulse width of t ($^\circ\text{C}/\text{W}$)

In the case of a through-hole diode that can be attached to a heatsink, its steady-state and transient power dissipation can be calculated using Equations 1-5 and 1-6, respectively:

$$P_D = \frac{T_j - 25 \text{ } ^\circ\text{C}}{R_{th(j-c)}} \dots\dots\dots (1-5)$$

- P_D : Power dissipation
- T_j : Junction temperature ($^\circ\text{C}$)
- $R_{th(j-c)}$: Junction-to-case thermal resistance ($^\circ\text{C}/\text{W}$)

$$P_{DP} = \frac{T_j - 25}{r_{th(j-c)(t)}} \dots\dots\dots (1-6)$$

- P_D : Power dissipation (W)
- T_j : Junction temperature ($^\circ\text{C}$)
- $r_{th(j-c)(t)}$: Junction-to-case thermal impedance at a pulse width of t ($^\circ\text{C}/\text{W}$)

1.2.3. Storage temperature (T_{stg})

T_{stg} is the ambient temperature range in which a diode can be stored without voltage application. The properties and reliability of the materials that constitute the device except those of a silicon chip determine the storage temperature range. Care should also be taken to prevent oxidation of diode terminals during storage.

Characteristic	Symbol	Rating	Unit
Storage temperature	T_{stg}	-55 to 150	$^\circ\text{C}$

1.2.4. Isolation voltage ($V_{ISO(RMS)}$ or V_{dis})

For diodes housed in a fully molded package^{*1}, isolation voltage represents the level of electrical isolation between the surface of mold resin and electrode terminals. To confirm the $V_{ISO(RMS)}$ (V_{dis}) characteristic, the diode is tested by applying AC voltage for a specified period of time. Isolation voltage is specified as the RMS of AC voltage.

*1 Insulated package covered by mold resin

Characteristic	Symbol	Rating	Unit
Isolation voltage	$V_{ISO(RMS)}$ ^{Note1}	2000	V

Note 1: $t = 1 \text{ s}$

1.2.5. Mounting torque, TOR

TOR is the maximum torque that can be applied when attaching a through-hole diode to a heatsink using a screw with a washer. When attaching diodes to a thermal fin, the specified mounting torque must be followed. If the torque is too low, the mounting screws will loosen, reducing the heat dissipation performance. If the torque is too high, the device could be damaged.

Characteristic	Symbol	Rating	Unit
Mounting torque	TOR	0.6	N·m

Table 1-1 Maximum mounting torque for through-hole diodes

Package	Mounting torque
TO-220-2L	0.6 N·m
TO-220F-2L	0.6 N·m
TO-247	0.8 N·m

1.3. Maximum ratings common to switching diodes, rectifier diodes, Si Schottky barrier diodes (SBDs), and SiC SBDs

1.3.1. Voltage ratings

(1) Peak repetitive reverse voltage (V_{RRM})

V_{RRM} is the maximum allowable instantaneous voltage that can be applied repeatedly in the reverse direction at a T_a of 25 °C or at a temperature specified in the datasheet. It is specified as the peak half-sine-wave voltage at a utility frequency.

Characteristic	Symbol	Rating	Unit
Peak repetitive reverse voltage	V_{RRM}	400	V

(2) Peak reverse voltage (V_{RM})

V_{RM} is the peak voltage of an AC signal that can be applied in the reverse direction, with its average value being less than V_R .

Characteristic	Symbol	Rating	Unit
Peak reverse voltage	V_{RM}	85	V

(3) Reverse voltage (V_R)

V_R is the maximum DC voltage that can be applied in the reverse direction at a T_a of 25 °C or at a temperature specified in the datasheet.

Characteristic	Symbol	Rating	Unit
Reverse voltage	V_R	80	V

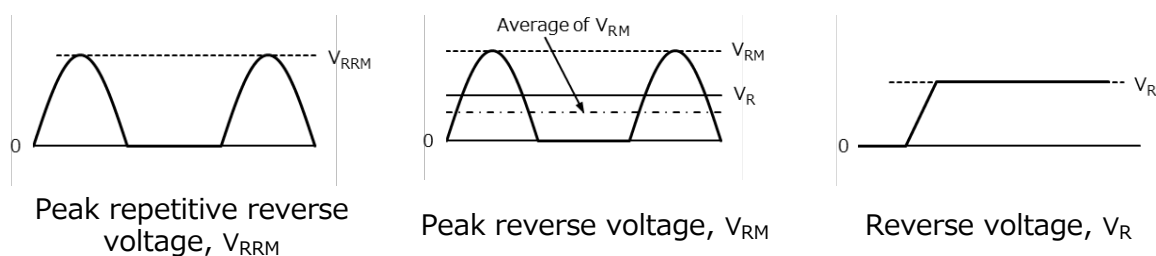

Figure 1.1 Definitions of voltage ratings

1.3.2. Current ratings

1.3.2.1. Steady-state current ratings

The following ratings specify the amount of current that can be repeatedly applied to a diode operating in a steady state. These ratings are constrained by the rated junction temperature (T_j).

(1) Average forward current ($I_{F(AV)}$)

$I_{F(AV)}$ is the maximum average current of a half sine wave (with a conduction angle of 180°) with the utility frequency (50 Hz or 60 Hz) that a diode can conduct at the specified temperature or the average forward current of a rectangular wave that a diode can conduct under the specified conditions.

Characteristic	Symbol	Rating	Unit
Average forward current	$I_{F(AV)}$	1	A

(2) Average rectified forward current (I_O)

I_O is the maximum average current of a full sine wave (with a conduction angle of 360°) with the utility frequency (50 Hz or 60 Hz) that a diode can conduct at the specified temperature or the average forward current of a rectangular wave that a diode can conduct in the forward direction under the specified conditions.

Characteristic	Symbol	Rating	Unit
Average rectified current	I_O	100	mA

(3) Forward DC current ($I_{F(DC)}$)

$I_{F(DC)}$ is the maximum allowable DC current that a diode can conduct in the forward direction under the specified conditions.

Characteristic	Symbol	Rating	Unit
Forward DC current	$I_{F(DC)}$	12	A

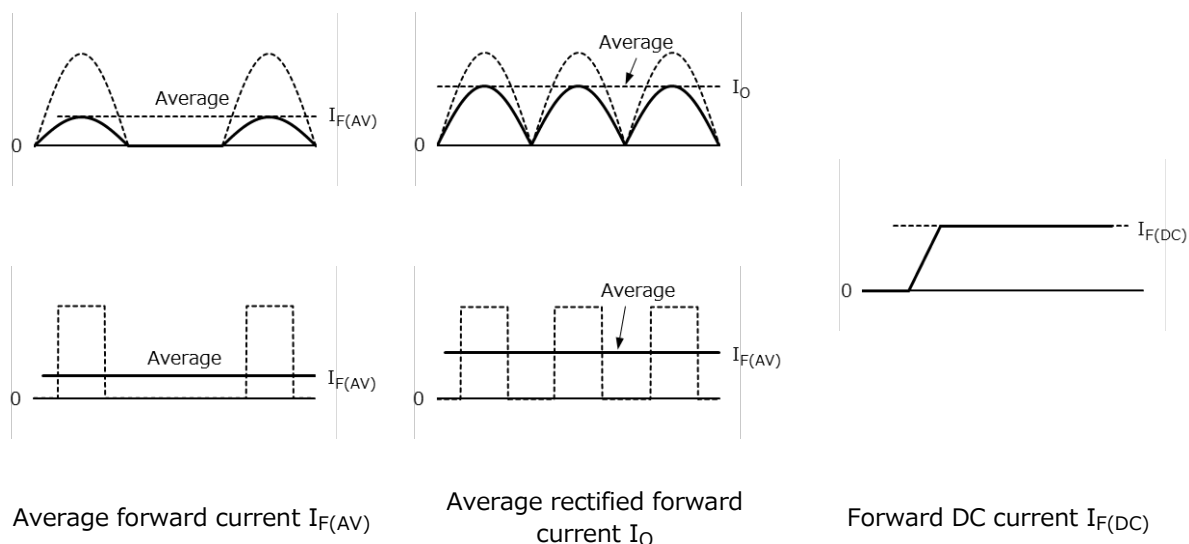

Figure 1.2 Definitions of steady-state current ratings

1.3.2.2. Instantaneous pulse current ratings

The following ratings specify the amount of current that a diode can conduct only once, but not repeatedly, under the specified conditions. These ratings are for current conditions to which a diode is seldom exposed during its lifespan.

(1) Peak forward current (I_{FM})

I_{FM} is the maximum AC current that a diode can conduct at the specified temperature within an extent that does not exceed the average rectified forward current (I_O).

Characteristic	Symbol	Rating	Unit
Peak forward voltage	I_{FM}	300	mA

(2) Forward pulse current (I_{FP})

I_{FP} is the maximum rectangular wave current with the specified pulse width that a diode can conduct in the forward direction under the specified conditions.

Characteristic	Symbol	Note	Rating	Unit
Forward pulse current	I_{FP}	(Note 2)	120	A

Note 2: $t = 50 \mu s$

(3) Non-repetitive peak forward current (I_{FSM})

I_{FSM} is the maximum current that does not destroy a diode. It is specified for a half sine wave applied in the forward direction for one cycle at the utility frequency (50 or 60 Hz), a rectangular wave with a pulse width of 10 ms, or a current with the specified conditions.

Characteristic	Symbol	Note	Rating	Unit
Non-repetitive peak forward current	I_{FSM}	(Note 3)	97	A

Note 3: $f = 50$ Hz (Half sine wave: $t = 10$ ms)

(4) I^2t limit value (I^2t)

I^2t is the peak current of a single-shot half sine wave with a pulse width of 10 ms or less that can be applied to a diode in the forward direction. I^2t can be calculated using Equation 1-7.

Characteristic	Symbol	Rating	Unit
I^2t limit value	I^2t	18	A

$$I^2t = \left[\frac{I_{FSM} (50 \text{ Hz})}{\sqrt{2}} \right]^2 \times 0.01 \dots\dots\dots (1-7)$$

- I : RMS current during conduction (A)
- t : Pulse width (s)
- I_{FSM} : Non-repetitive peak forward current (A)

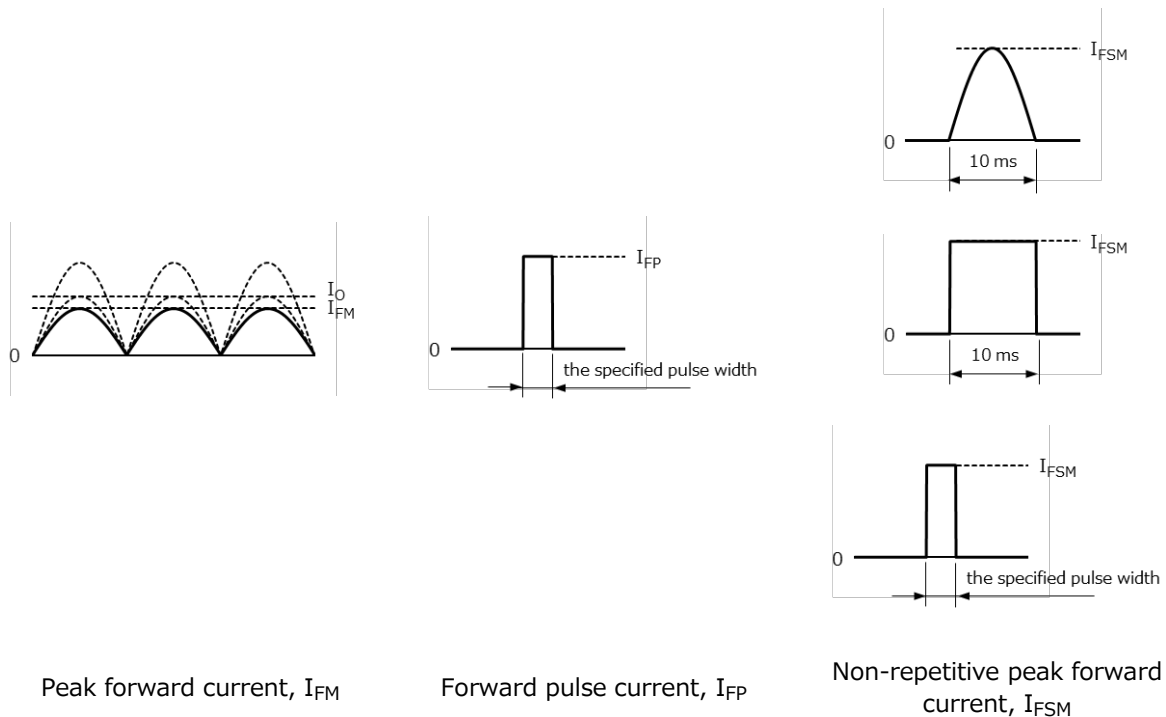

Figure 1.3 Definitions of instantaneous pulse current ratings

1.4. Ratings common to TVS (ESD protection) and Zener diodes

1.4.1. Electrostatic discharge voltage (IEC 61000-4-2) (contact), V_{ESD}

V_{ESD} is the ESD tolerance to a contact discharge, i.e., a discharge through a direct contact with a equipment under protection. The ESD tolerance is measured according to the method and the ESD waveform specified in the IEC 61000-4-2 standard from the International Electrotechnical Commission (IEC). The specified V_{ESD} value is the peak value of the test waveform.

Characteristic	Symbol	Rating	Unit
Electrostatic discharge voltage (IEC 61000-4-2) (contact)	V_{ESD}	±15	kV

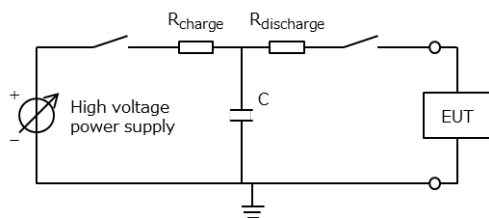

Figure 1.4 Example of an IEC 61000-4-2 test circuit

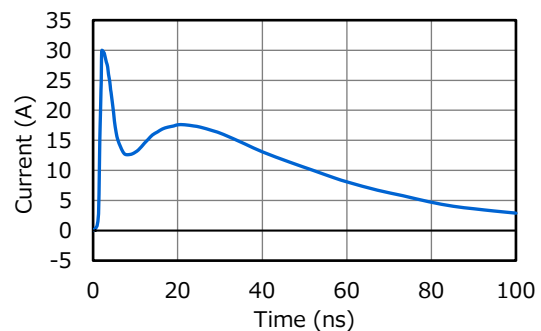

Figure 1.5 Example of an IEC 61000-4-2 test waveform

1.4.2. Electrostatic discharge voltage (IEC 61000-4-2) (air), V_{ESD}

V_{ESD} is the ESD tolerance to an air discharge, i.e., a discharge that occurs between equipment under test (EUT) and a discharge gun through an air layer. The test method and the ESD waveform are the same as those shown in Section 1.4.1.

Characteristic	Symbol	Rating	Unit
Electrostatic discharge voltage (IEC 61000-4-2) (air)	V_{ESD}	±15	kV

1.4.3. Peak pulse power ($t_p = 8/20 \mu s$), P_{PK}

P_{PK} is the maximum surge power that can be shunted before a TVS diode itself is damaged. P_{PK} is measured using an 8/20 μs pulse waveform shown in Figure 1.7. (8/20 μs means that it takes 8 μs for the waveform to rise to 100% and 20 μs to fall from 100% to 50%.)

Characteristic	Symbol	Rating	Unit
Peak pulse power ($t_p = 8/20 \mu s$)	P_{PK}	15	W

1.4.4. Peak pulse current ($t_p = 8/20 \mu s$), I_{PP}

I_{PP} is the peak surge current that can be shunted before a TVS protection diode itself is damaged. As is the case with peak pulse power, I_{PP} is measured using the waveform shown in Figure 1.7.

Characteristic	Symbol	Rating	Unit
Peak pulse current ($t_p = 8/20 \mu s$)	I_{PP}	0.5	A

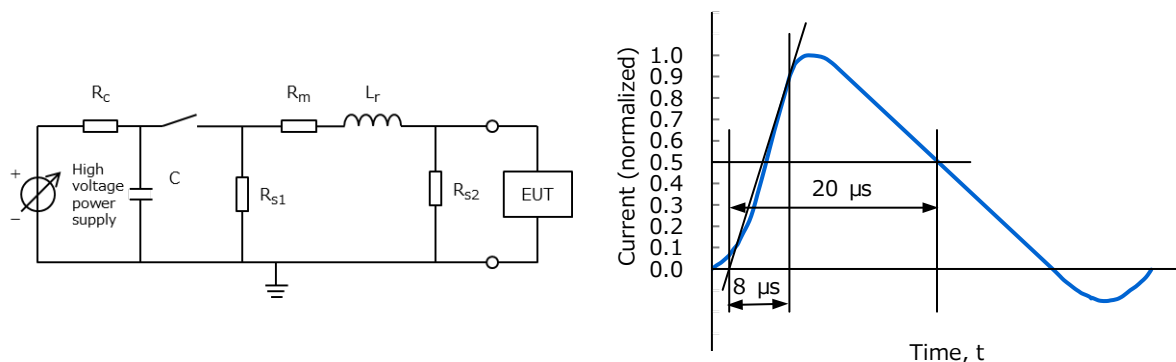

Figure 1.6 Example of an IEC 61000-4-5 test circuit
 Figure 1.7 Example of an IEC 61000-4-5 test waveform

2. Electrical characteristics

2.1. Electrical characteristics common to switching diodes, rectifier diodes, Si SBDs, and SiC SBDs

2.1.1. Forward voltage (V_F) and peak forward voltage (V_{FM})

Forward voltage is a voltage drop that occurs between the anode and cathode of a diode when it conducts the specified current in the forward direction at the specified temperature. Generally, the forward voltage of a Si diode has a negative temperature coefficient whereas the forward voltage of a SiC SBD has a positive temperature coefficient in the high-current region. Therefore, when multiple Si diodes are connected in parallel under high-temperature, high-voltage conditions, care should be exercised as to thermal runaway.

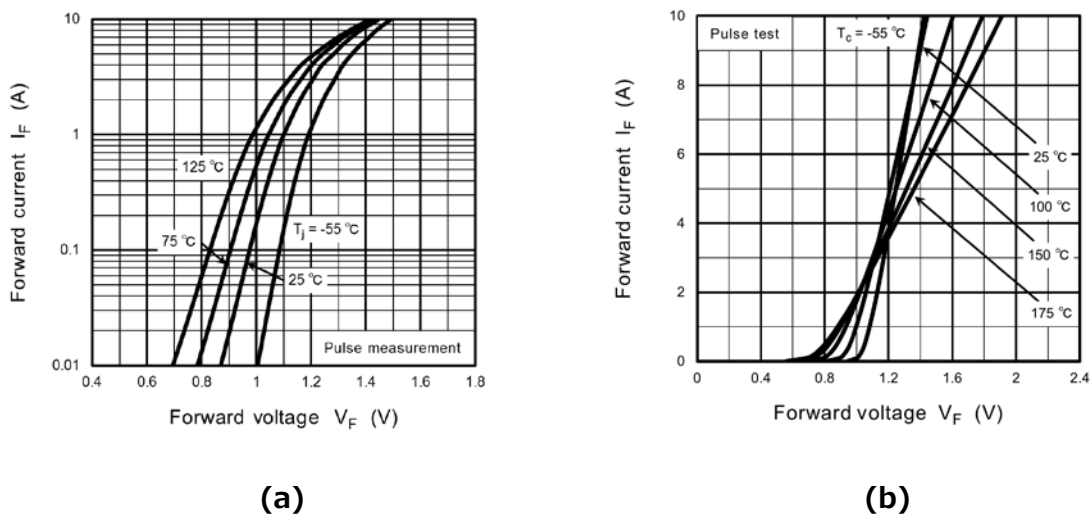

Figure 2.1 Examples of forward current-vs-forward voltage curves of Si and SiC SBDs

Figure 2.1(b) shows an example of I_F - V_F curves of a SiC SBD. In the low- I_F region, forward voltage (V_F) has a negative temperature coefficient as is the case with the Si SBD shown in Figure 2.1(a). In the high- I_F region, however, V_F has a positive temperature coefficient. The following two factors contribute to the changes in the semiconductor resistance due to temperature change:

- (1) Excitation of donor electrons to the conduction band (a decrease in resistance)
- (2) Diffusion of electrons caused by lattice vibration (an increase in resistance)

Because of a strong atomic bond, wide-bandgap semiconductors such as SiC are affected more by lattice vibration than silicon. In addition, donors are less likely to be excited in SiC than in silicon owing to a wide bandgap. Therefore, the excitation of donor electrons to the conduction band has a significant impact on the semiconductor resistance in the low- I_F region whereas the effect of the diffusion of electrons caused by lattice vibration has more influence as I_F increases. Consequently, a

SiC SBD exhibits I_F - V_F curves as shown in Figure 2-1(b). This phenomenon also occurs in a Si diode at high current when the rated average forward current or DC forward current is exceeded. Therefore, when connected in parallel, Si diodes are susceptible to a positive feedback effect because of a reduction in resistance caused by the thermal excitation of donor electrons. In contrast, SiC SBDs have negative feedback in the high- I_F region because of an increase in resistance caused by the diffusion of electrons. By using this region, multiple SiC SBDs can be connected in parallel relatively easily as long as care is exercised as to forward current.

2.1.2. Reverse current (I_R) and peak repetitive reverse current (I_{RRM})

I_R and I_{RRM} are the amount of current that flows in the reverse direction from cathode to anode when the specified reverse voltage is applied across a diode.

Generally, the I_{RRM} of a Si diode depends on temperature as indicated by Equation 3-1. I_{RRM} increases exponentially as junction temperature (T_j) increases.

$$I_{RRM} \approx I_S \cdot \exp\left(-\frac{q \cdot V_R}{2 \cdot K \cdot T_j}\right) \dots\dots\dots (2-1)$$

- I_{RRM} : Reverse current of a Si diode (A)
- I_S : Saturation current (A)
- q : Electron charge (C)
- V_R : Reverse voltage applied (V)
- K : Boltzmann constant (1.381×10^{-23}) ($J \cdot K^{-1}$)
- T_j : Junction temperature (in Kelvin) (K)

SBDs and high-speed rectifier diodes such as fast recovery diodes (FRDs) have higher I_{RRM} than typical Si rectifier diodes. Therefore, under high-temperature and high-voltage conditions, an increase in reverse power dissipation might cause thermal runaway, leading to device destruction or degradation. Therefore, these diodes require thermal design, taking both forward and reverse power dissipation into consideration.

2.1.3. Total capacitance (C_t) and junction capacitance (C_j)

C_t and C_j are the capacitance between the terminals of a diode when reverse voltage is applied across anode and cathode.

2.1.4. Total capacitive charge (Q_{cj})

Q_{cj} is specified for SiC SBDs. It is the total charge required to charge and discharge the junction capacitance present between anode and cathode. Q_{cj} can be calculated as follows:

$$Q_{cj} = \int C_j \cdot V_{AK} dv \quad \dots \dots \dots (2-2)$$

- C_{cj} : Total capacitive charge (C)
- C_j : Junction capacitance (F)
- V_{AK} : Reverse voltage across cathode and anode (V)

2.1.5. Forward recovery time (t_{fr})

t_{fr} is the turn-on time of a diode required to conduct current in the forward direction as shown in Figure 2.3. When a rapidly rising pulse is applied across a diode, it does not enter a conducting state immediately because of carrier accumulation. During a period of t_{fr} , a diode exhibits high resistance even in the forward direction. In other words, t_{fr} is the time required for current to spread toward the cathode end of a diode. t_{fr} is defined as the time required for forward voltage to reach its peak and then drop to 110 % of V_F at the specified forward current (I_F).

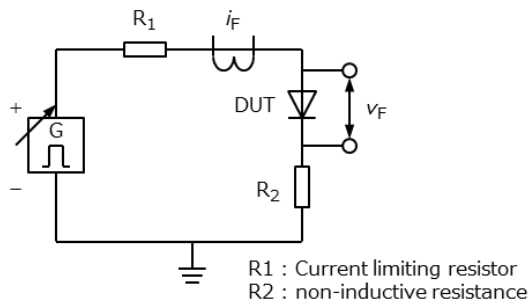

Figure 2.2 Example of a test circuit for forward recovery time (t_{fr})

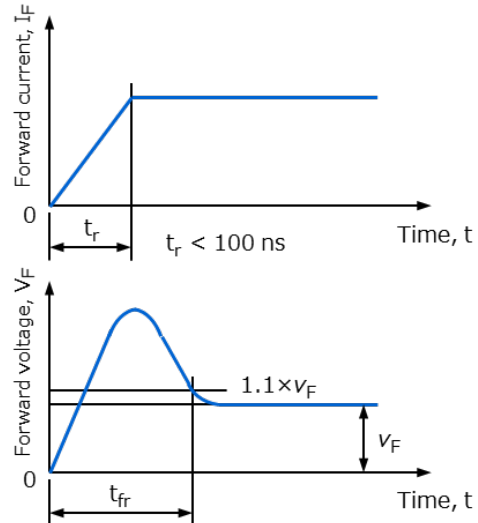

Figure 2.3 Example of a waveform showing forward recovery time (t_{fr})

2.1.6. Reverse recovery time (t_{rr})

t_{rr} is the time required for the reverse recovery current to decay under the specified conditions until a diode recovers. t_{rr} is defined as the time between the instant at which the forward current (i_F) becomes zero and the instant at which the reverse recovery time decays to 10 % of peak reverse current (i_{rr}).

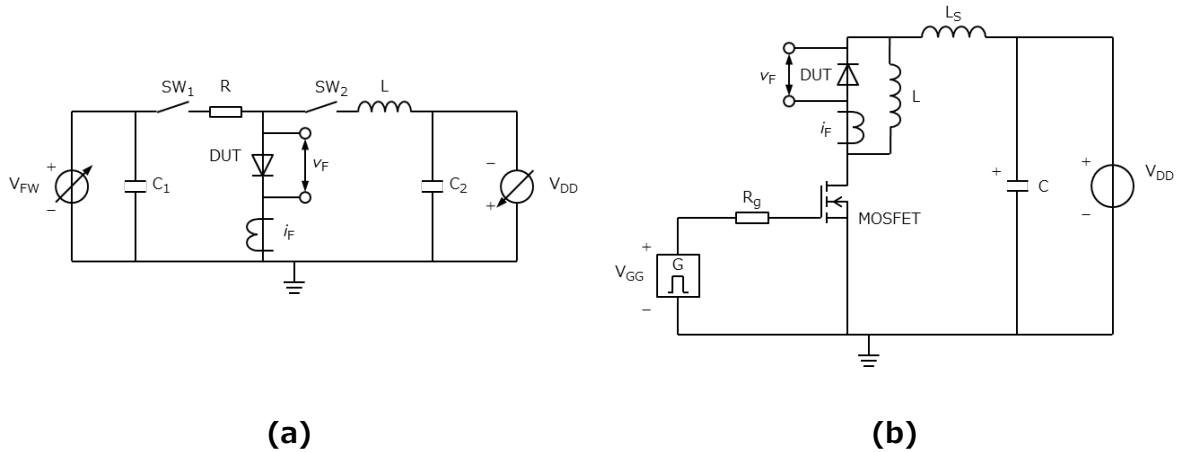

Figure 2.4 Example of a test circuit for reverse recovery time (t_{rr})

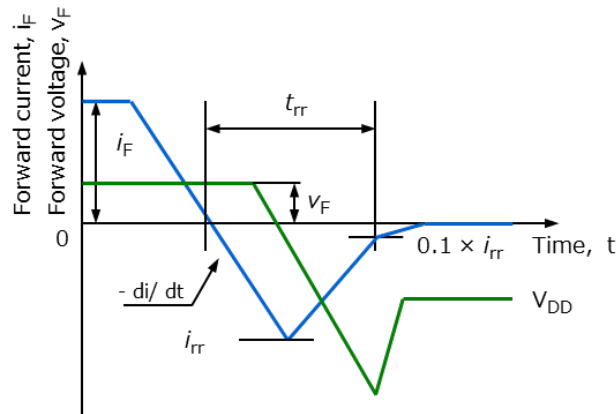

Figure 2.5 Example of a waveform showing reverse recovery time (t_{rr})

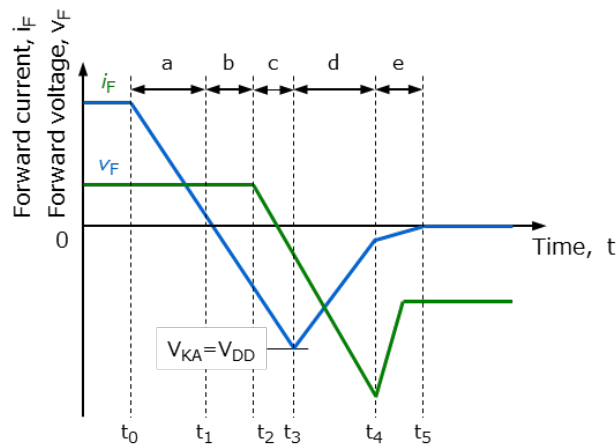

Figure 2.6 Reverse recovery operation

The following describes the operation of a diode during the period of t_{rr} using the circuit of Figure 2.4(b).

Period a ($t_0 \rightarrow t_1$)

The diode transitions from the "on" state to the "off" state. Holes are attracted to the cathode while electrons are attracted to the anode. As a result, current decreases linearly.

Period b ($t_1 \rightarrow t_2$)

Current flows in the reverse direction to sweep out the carriers accumulated in the n^- region.

Period c ($t_2 \rightarrow t_3$)

After the cathode-anode voltage (V_{KA}) of the diode becomes zero, a depletion layer begins to expand, increasing V_{KA} . The accumulated carriers are still being swept out of the n^- region. The reverse current becomes the maximum when $V_{KA} = V_{DD}$. The maximum value of this reverse current is called the reverse recovery current (i_{rr}).

Period d ($t_3 \rightarrow t_4$)

Normally, a circuit has stray inductance (L_S). Therefore, the sum of $V_{surge} = L_S \frac{di}{dt}$ and V_{DD} is applied across the cathode and anode of the diode. Care should be taken to ensure that it does not exceed its withstand voltage. During this period, reverse current continues flowing as the accumulated carriers are still being swept out of the n^- region.

Period d ($t_4 \rightarrow t_5$)

The depletion layer expands to a width proportional to the reverse bias voltage (V_{DD}). The reverse current gradually decays as the remaining carriers recombine and disappear.

Test condition: $i_F = 1 \text{ A}$, $di/dt = -30 \text{ A}/\mu\text{s}$, $T_a = 25^\circ\text{C}$

Vertical axis: Current (0.5 A/div)
Horizontal axis: Time (50 ns/div)

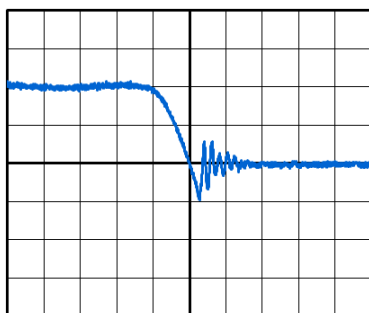

Figure 2.7 Example of a waveform of a high-efficiency diode (HED) during t_{rr}

Vertical axis: Current (0.5 A/div)
Horizontal axis: Time (50 ns/div)



Figure 2.8 Example of a waveform of a super-fast-recovery diode (S-FRD) during t_{rr}

Vertical axis: Current (2 A/div)
Horizontal axis: Time (100 ns/div)

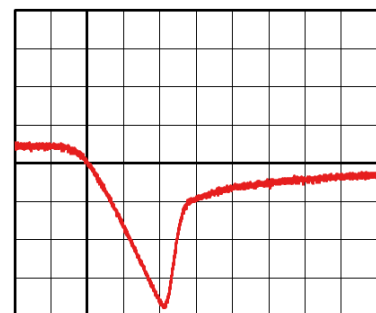

Figure 2.9 Example of a waveform of a general-purpose diode during t_{rr}

In contrast to the pn diode, a Schottky barrier diode provides zero reverse recovery time (t_{rr}) since it is a unipolar device. However, a recovery waveform equivalent to t_{rr} is observed because of junction capacitance. Still, the recovery current and the time during which it persists are much smaller, compared to high-efficiency diodes (HEDs)^{*2}.

*2: Also known as low-loss diodes (LLDs)

Test conditions: $i_F=1\text{ A}$, $di/dt=-30\text{ A}/\mu\text{s}$, $T_a=25^\circ\text{C}$

Vertical axis: Current (0.5 A/div)
Horizontal axis: Time (50 ns/div)

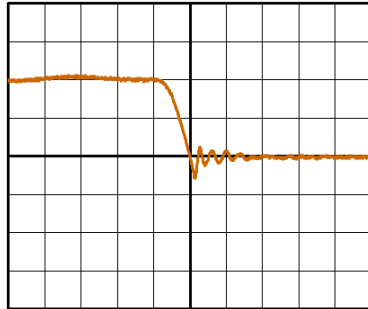

Vertical axis: Current (0.5 A/div)
Horizontal axis: Time (50 ns/div)

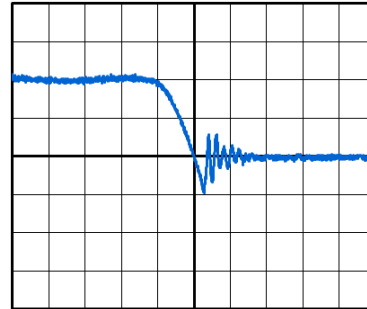

Figure 2.10 Example of an SBD recovery waveform

Figure 2.11 Example of an HED recovery waveform

2.2. Electrical characteristics common to TVS (ESD protection) and Zener diodes

2.2.1. Working peak reverse voltage, V_{RWM} (TVS diodes)

V_{RWM} is the minimum reverse voltage value at which the TVS diodes can maintain a very high resistance state. The designer can use this parameter as a guide to ensure that it is above the maximum operating voltage of a signal line to be protected.

2.2.2. Reverse breakdown voltage, V_{BR} (TVS diodes)

V_{BR} is the reverse voltage across a TVS diode when it conducts the specified reverse current from cathode to anode. V_{BR} is defined as the voltage at which a TVS protection diode turns on.

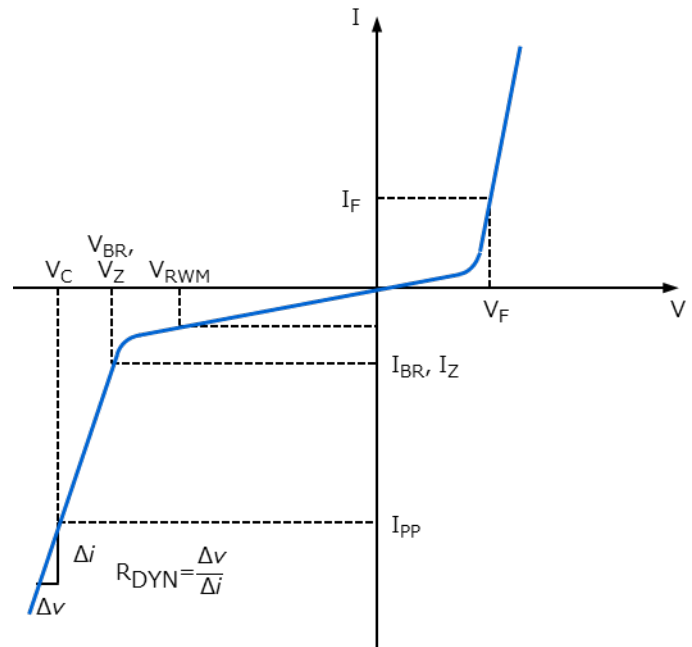

Figure 2-12 Definitions of electrical characteristics

2.2.3. Clamp voltage, V_C (TVS diodes)

V_C is the maximum reverse voltage to which a TVS diode is clamped when exposed to the specified peak pulse current. The datasheet shows the clamp voltage for the peak pulse current with an 8/20 μs waveform. The clamp voltage represents the protection performance of a TVS diode along with the dynamic resistance described in Section 2.2.7.

2.2.4. Zener voltage, V_Z (Zener diodes)

V_Z is the reverse voltage when a Zener diode conducts the specified reverse current from cathode to anode.

2.2.5. Forward voltage, V_F (Zener diodes)

V_F is the forward voltage when a diode conducts the specified forward current from anode to cathode.

2.2.6. Reverse current, I_R (TVS and Zener diodes)

I_R is the amount of current that flows in the reverse direction from cathode to anode when the specified voltage is applied across them.

2.2.7. Dynamic resistance, R_{DYN} (TVS and Zener diodes)

R_{DYN} is the dynamic resistance under a condition in which a TVS diode is in reverse breakdown, conducting large reverse current. R_{DYN} is measured as a rate of change of reverse voltage with respect to a small change in reverse current. It is calculated from the measurements at two current points using the least-squares method. Dynamic resistance is measured using a TLP test^{*3}. Test conditions are shown in the datasheet.

*3 Transmission line pulse (TLP)

A test for evaluating the protection performance of a device under test by measuring its voltage and current after a square pulse is applied to it.

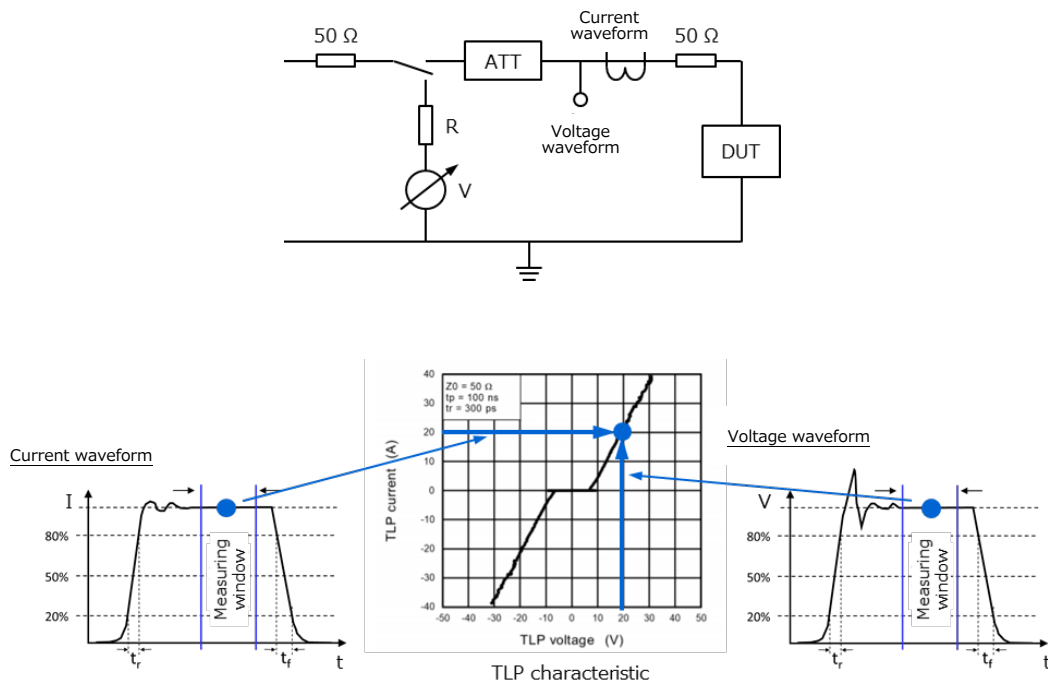

Figure 2.13 Example of a TLP test

2.2.8. Dynamic resistance, Z_Z or r_d (Zener diodes)

Dynamic resistance is the resistance of a Zener diode when it is in breakdown mode. As is the case with R_{DYN} , Z_Z (r_d) can also be measured as a rate of change of reverse voltage with respect to a small change in reverse current. It represents the slope of the Zener voltage of a Zener diode when it enters breakdown.

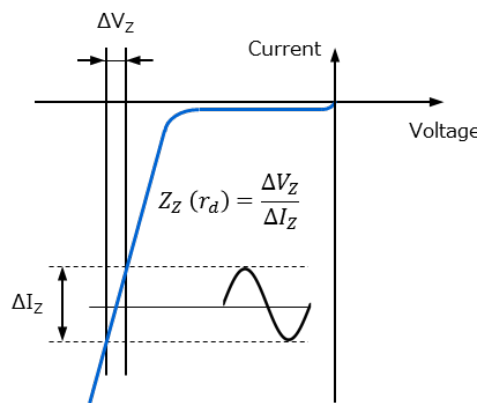

Figure 2.14 Z_Z (r_d) of a Zener diode

2.2.9. Temperature coefficient, α_T (Zener diodes)

α_T is a rate of change of Zener voltage with respect to ambient temperature. When $V_Z < 5$ to 6 V, Zener breakdown is generally predominant. Zener voltage has a negative temperature coefficient. When $V_Z > 5$ to 6 V, avalanche breakdown is predominant. Avalanche breakdown voltage has a

positive temperature coefficient, which becomes zero when V_Z is 5 to 6 V.

The temperature coefficient for Zener voltage is calculated from Zener voltages V_{Z1} and V_{Z2} at temperatures T_1 and T_2 .

$$\alpha_T = \frac{V_{Z2} - V_{Z1}}{T_2 - T_1} = \frac{\Delta V_Z}{\Delta T} \quad (\text{mV/ } ^\circ\text{C}) \quad \dots\dots\dots (2-2)$$

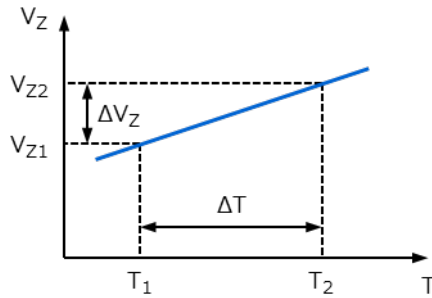

Figure 2.15 Definition of the temperature coefficient (α_T)

2.2.10. Total capacitance, C_t (TVS and Zener diodes)

C_t is the capacitance between cathode and anode when the specified signal is applied to a TVS or Zener diode.

- To perform a parametric search of switching diodes → [Click Here](#)
- To perform a parametric search of rectifier diodes → [Click Here](#)
- To visit a web page on Schottky barrier diodes → [Click Here](#)
- To perform a parametric search of Schottky barrier diodes → [Click Here](#)
- To visit a web page on SiC Schottky barrier diodes → [Click Here](#)
- To perform a parametric search of SiC Schottky barrier diodes → [Click Here](#)
- To visit a web page on TVS (ESD protection) diodes → [Click Here](#)
- To perform a parametric search of TVS (ESD protection) diodes → [Click Here](#)
- To visit a web page on Zener diodes → [Click Here](#)
- To perform a parametric search of Zener diodes → [Click Here](#)
- To download the application note "SiC Schottky Barrier Diodes" → [Click Here](#)
- To download the application note "SiC Schottky Barrier Diodes: Absolute Maximum Ratings and Electrical Characteristics" → [Click Here](#)
- To download the application note "Selecting Schottky Barrier Diodes for Voltage Boost Circuits" → [Click Here](#)
- To download the application note "Basics of ESD Protection (TVS) Diodes" → [Click Here](#)
- To download the application note "Overvoltage protection device Zener diode and ESD protection diode" → [Click Here](#)
- To visit an FAQ web page on diodes → [Click Here](#)
- Reference Design Center → [Click Here](#)

RESTRICTIONS ON PRODUCT USE

Toshiba Corporation and its subsidiaries and affiliates are collectively referred to as "TOSHIBA". Hardware, software and systems described in this document are collectively referred to as "Product".

- TOSHIBA reserves the right to make changes to the information in this document and related Product without notice.
- This document and any information herein may not be reproduced without prior written permission from TOSHIBA. Even with TOSHIBA's written permission, reproduction is permissible only if reproduction is without alteration/omission.
- Though TOSHIBA works continually to improve Product's quality and reliability, Product can malfunction or fail. Customers are responsible for complying with safety standards and for providing adequate designs and safeguards for their hardware, software and systems which minimize risk and avoid situations in which a malfunction or failure of Product could cause loss of human life, bodily injury or damage to property, including data loss or corruption. Before customers use the Product, create designs including the Product, or incorporate the Product into their own applications, customers must also refer to and comply with (a) the latest versions of all relevant TOSHIBA information, including without limitation, this document, the specifications, the data sheets and application notes for Product and the precautions and conditions set forth in the "TOSHIBA Semiconductor Reliability Handbook" and (b) the instructions for the application with which the Product will be used with or for. Customers are solely responsible for all aspects of their own product design or applications, including but not limited to (a) determining the appropriateness of the use of this Product in such design or applications; (b) evaluating and determining the applicability of any information contained in this document, or in charts, diagrams, programs, algorithms, sample application circuits, or any other referenced documents; and (c) validating all operating parameters for such designs and applications. **TOSHIBA ASSUMES NO LIABILITY FOR CUSTOMERS' PRODUCT DESIGN OR APPLICATIONS.**
- **PRODUCT IS NEITHER INTENDED NOR WARRANTED FOR USE IN EQUIPMENTS OR SYSTEMS THAT REQUIRE EXTRAORDINARILY HIGH LEVELS OF QUALITY AND/OR RELIABILITY, AND/OR A MALFUNCTION OR FAILURE OF WHICH MAY CAUSE LOSS OF HUMAN LIFE, BODILY INJURY, SERIOUS PROPERTY DAMAGE AND/OR SERIOUS PUBLIC IMPACT ("UNINTENDED USE").** Except for specific applications as expressly stated in this document, Unintended Use includes, without limitation, equipment used in nuclear facilities, equipment used in the aerospace industry, lifesaving and/or life supporting medical equipment, equipment used for automobiles, trains, ships and other transportation, traffic signaling equipment, equipment used to control combustions or explosions, safety devices, elevators and escalators, and devices related to power plant. **IF YOU USE PRODUCT FOR UNINTENDED USE, TOSHIBA ASSUMES NO LIABILITY FOR PRODUCT.** For details, please contact your TOSHIBA sales representative or contact us via our website.
- Do not disassemble, analyze, reverse-engineer, alter, modify, translate or copy Product, whether in whole or in part.
- Product shall not be used for or incorporated into any products or systems whose manufacture, use, or sale is prohibited under any applicable laws or regulations.
- The information contained herein is presented only as guidance for Product use. No responsibility is assumed by TOSHIBA for any infringement of patents or any other intellectual property rights of third parties that may result from the use of Product. No license to any intellectual property right is granted by this document, whether express or implied, by estoppel or otherwise.
- **ABSENT A WRITTEN SIGNED AGREEMENT, EXCEPT AS PROVIDED IN THE RELEVANT TERMS AND CONDITIONS OF SALE FOR PRODUCT, AND TO THE MAXIMUM EXTENT ALLOWABLE BY LAW, TOSHIBA (1) ASSUMES NO LIABILITY WHATSOEVER, INCLUDING WITHOUT LIMITATION, INDIRECT, CONSEQUENTIAL, SPECIAL, OR INCIDENTAL DAMAGES OR LOSS, INCLUDING WITHOUT LIMITATION, LOSS OF PROFITS, LOSS OF OPPORTUNITIES, BUSINESS INTERRUPTION AND LOSS OF DATA, AND (2) DISCLAIMS ANY AND ALL EXPRESS OR IMPLIED WARRANTIES AND CONDITIONS RELATED TO SALE, USE OF PRODUCT, OR INFORMATION, INCLUDING WARRANTIES OR CONDITIONS OF MERCHANTABILITY, FITNESS FOR A PARTICULAR PURPOSE, ACCURACY OF INFORMATION, OR NONINFRINGEMENT.**
- Do not use or otherwise make available Product or related software or technology for any military purposes, including without limitation, for the design, development, use, stockpiling or manufacturing of nuclear, chemical, or biological weapons or missile technology products (mass destruction weapons). Product and related software and technology may be controlled under the applicable export laws and regulations including, without limitation, the Japanese Foreign Exchange and Foreign Trade Law and the U.S. Export Administration Regulations. Export and re-export of Product or related software or technology are strictly prohibited except in compliance with all applicable export laws and regulations.
- Please contact your TOSHIBA sales representative for details as to environmental matters such as the RoHS compatibility of Product. Please use Product in compliance with all applicable laws and regulations that regulate the inclusion or use of controlled substances, including without limitation, the EU RoHS Directive. **TOSHIBA ASSUMES NO LIABILITY FOR DAMAGES OR LOSSES OCCURRING AS A RESULT OF NONCOMPLIANCE WITH APPLICABLE LAWS AND REGULATIONS.**