

Introduction to Load Switch ICs

TOSHIBA Load Switch ICs Contribute to Shorter Design Periods and Higher Equipment Performance

A load switch is a switch (= high-side switch) connected in series between the power supply and the load. It is used to set the power sequence for reliable operation of complex systems in the equipment and to disconnect circuits that are not required for operation for the purpose of reducing power consumption.

The load switch IC is an IC that incorporates a wealth of functions into this load switch. It is compact [Note] compared to a load switch in a discrete configuration, allowing a more reliable system to be constructed. [Note] Comparison with our products

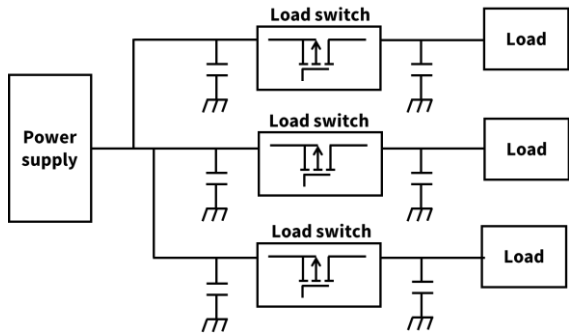

Example of using load switch IC

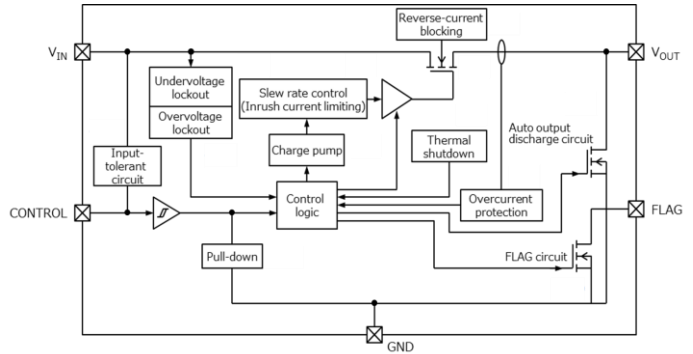

Example of Load Switch IC Block Diagram

Lineup of compact products with a variety of additional functions and space-saving capabilities

The load switch IC has a variety of additional functions, such as inrush current reduction, reverse current prevention, overcurrent protection, thermal shutdown, and automatic output discharge, which become complicated in conventional circuit configurations composed of discrete components, in a single chip IC. High performance system is easily realized with small area and low cost.

The lineup of packages is centered on small products of 1mm in size, and we offer products that are ideal for mobile, wearable, IoT equipment, and other applications that require particularly small space.

Built in Multi-Function In small package

Safer and better quality.

Simplify Design circuit

Discrete devices necessary to create a load switch

Output transistor	Driver and discharge transistors
Diode for reverse-current protection	Passive components

Reduce discrete passive and active components.

Low Input Voltage Operation/Low On-Resistance Characteristics

The low on-resistance (low R_{ON}) type load switch IC realizes low-voltage operation at 0.75V (TCK20x series) and ultra-low R_{ON} of 8m Ω (TCK11x series) in a compact package by incorporating a charge pump circuit (step-up circuit) inside. In addition, it has low on-resistance characteristics that are flat against output current and input voltage. Therefore, it is possible to maintain low loss because of low R_{ON} at all times regardless of changes in operating conditions.

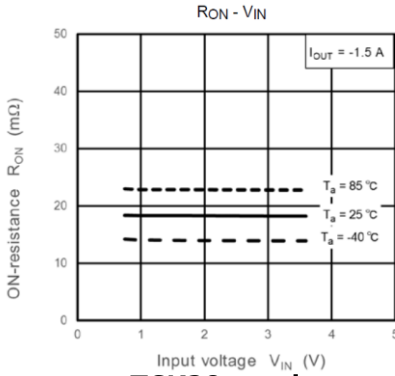

TCK20x series

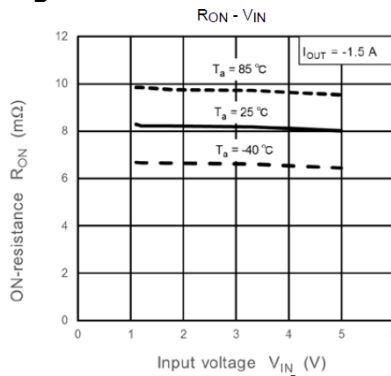

TCK11x series

● [TCK20x series](#) [Click](#)

● [TCK11x series](#) [Click](#)

Low Current Consumption Characteristics

TCK12xBG series are the latest series featuring 0.08nA (normal) and very low current dissipation. Compared with our conventional product "TCK107AG", it has been significantly reduced by about 99.9%.

The input voltage of this series can be operated from 1.0V to 5.5V. This low current consumption and wide voltage range can be used on the main power lines of mobile and wearable equipment.

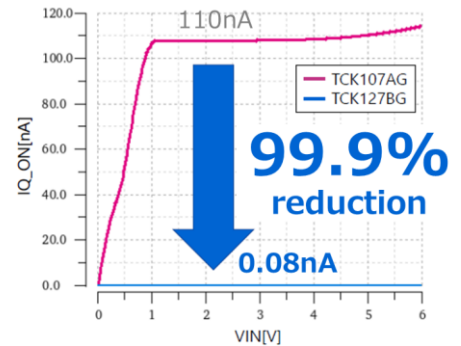

Note) The above figure is a design simulation result and is subject to change without notice.

● [TCK12xBG series](#) [Click](#)

Overcurrent protection function

The overcurrent protection function of the load switch IC limits the output current I_{OUT} by controlling the gate voltage of MOSFET inside the load switch when the output current reaches the internal overcurrent limit. This function is also called the current limit (Current Limit) or OCP (Over Current Protection).

Our load switch ICs use a foldback type of protection circuit (called the "foe" characteristic) control method.

The overcurrent limit value is fixed for each product. The product lineup ranges from a small current value of several hundred mA to a 1.0A or higher.

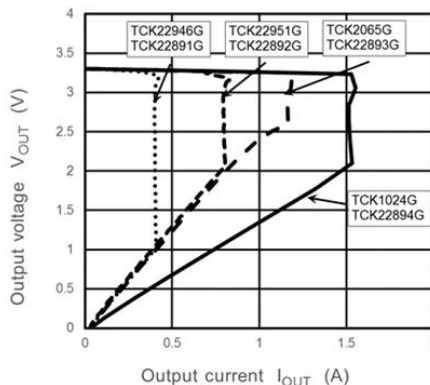







● [Application note](#) [Click](#)

Overcurrent protection characteristics

•Load switch IC selection table

Product name	Package	Size (mm)	Structure	Electrical Characteristics/Switching Characteristics							Additional function							Purchase
				Vin /V (Min)	Vin /V (Max)	Iout /A (DC)	RON /mΩ (typ) @1.2V	RON /mΩ (typ) @ 5.0V	Iq /μA (typ)	Slew Rate /μs (typ)	Control Active	Control Connection	OAD	RCB	OVP	OCP	TSD	
TCK22921G	WCSP6E	0.8x1.2	PMOS	1.1	5.5	>2	104	25	0.1	4.5	High	Pull down	Y	Y	N	N	N	Buy Online
TCK22922G	WCSP6E	0.8x1.2	PMOS	1.1	5.5	>2	104	25	1.4	666	High	Pull down	Y	Y	N	N	N	Buy Online
TCK22923G	WCSP6E	0.8x1.2	PMOS	1.1	5.5	>2	104	25	1.4	1364	High	Pull down	Y	Y	N	N	N	Buy Online
TCK22925G	WCSP6E	0.8x1.2	PMOS	1.1	5.5	>2	104	25	1.4	3380	High	Pull down	Y	Y	N	N	N	Buy Online
TCK22971G	WCSP6E	0.8x1.2	PMOS	1.1	5.5	>2	104	25	0.1	4.5	High	Pull down	N	Y	N	N	N	Buy Online
TCK22972G	WCSP6E	0.8x1.2	PMOS	1.1	5.5	>2	104	25	1.4	666	High	Pull down	N	Y	N	N	N	Buy Online
TCK22973G	WCSP6E	0.8x1.2	PMOS	1.1	5.5	>2	104	25	1.4	1364	High	Pull down	N	Y	N	N	N	Buy Online
TCK22974G	WCSP6E	0.8x1.2	PMOS	1.1	5.5	>2	104	25	1.4	3380	High	Pull down	N	Y	N	N	N	Buy Online
TCK22975G	WCSP6E	0.8x1.2	PMOS	1.1	5.5	>2	104	25	1.4	666	Low	Open	N	Y	N	N	N	Buy Online
TCK22913G	WCSP6E	0.8x1.2	PMOS	1.1	5.5	>2	141	31	11	1000	High	Pull down	Y	Y (On/Off)	N	N	Y	Buy Online
TCK22912G	WCSP6E	0.8x1.2	PMOS	1.1	5.5	>2	141	31	11	1000	High	Pull down	N	Y (On/Off)	N	N	Y	Buy Online
TCK22911G	WCSP6E	0.8x1.2	PMOS	1.1	5.5	>2	141	31	11	1000	Low	Open	Y	Y (On/Off)	N	N	Y	Buy Online
TCK22910G	WCSP6E	0.8x1.2	PMOS	1.1	5.5	>2	141	31	11	1000	Low	Open	N	Y (On/Off)	N	N	Y	Buy Online
TCK22946G	WCSP6E	0.8x1.2	PMOS	1.1	5.5	>2	141	31	25	50	High	Pull down	Y	Y (On/Off)	N	Y (0.4A)	Y	Buy Online
TCK22951G	WCSP6E	0.8x1.2	PMOS	1.4	5.5	>2	141	31	25	50	High	Pull down	Y	Y (On/Off)	N	Y (0.74A)	Y	Buy Online
TCK2065G	WCSP6E	0.8x1.2	PMOS	1.4	5.5	>2	141	31	25	50	High	Pull down	Y	Y (On/Off)	N	Y (1.11A)	Y	Buy Online
TCK1024G	WCSP6E	0.8x1.2	PMOS	1.4	5.5	>2	141	31	25	50	High	Pull down	Y	Y (On/Off)	N	Y (1.54A)	Y	Buy Online
TCK22891G	WCSP6E	0.8x1.2	PMOS	1.1	5.5	>2	141	31	25	50	High	Pull down	Y	N	N	Y (0.4A)	Y	Buy Online
TCK22892G	WCSP6E	0.8x1.2	PMOS	1.4	5.5	>2	141	31	25	50	High	Pull down	Y	N	N	Y (0.74A)	Y	Buy Online
TCK22893G	WCSP6E	0.8x1.2	PMOS	1.4	5.5	>2	141	31	25	50	High	Pull down	Y	N	N	Y (1.11A)	Y	Buy Online
TCK22894G	WCSP6E	0.8x1.2	PMOS	1.4	5.5	>2	141	31	25	50	High	Pull down	Y	N	N	Y (1.54A)	Y	Buy Online
TCK1064G	WCSP4D	0.8x0.8	PMOS	1.1	5.5	1	139	34	0.11	130	High	Pull down	N	N	N	N	N	Buy Online
TCK107AG	WCSP4D	0.8x0.8	PMOS	1.1	5.5	1	139	34	0.11	130	High	Pull down	Y	N	N	N	N	Buy Online
TCK108AG	WCSP4D	0.8x0.8	PMOS	1.1	5.5	1	139	34	0.11	130	Low	Open	Y	N	N	N	N	Buy Online
TCK106AF	SOT-25	2.8x2.9	PMOS	1.1	5.5	1	175	63	0.11	130	High	Pull down	N	N	N	N	N	Buy Online
TCK107AF	SOT-25	2.8x2.9	PMOS	1.1	5.5	1	175	63	0.11	130	High	Pull down	Y	N	N	N	N	Buy Online
TCK108AF	SOT-25	2.8x2.9	PMOS	1.1	5.5	1	175	63	0.11	130	Low	Open	Y	N	N	N	N	Buy Online
TCK111G	WCSP6C	1.0x1.5	NMOS	1.1	5.5	3	8.4	8.3	65	500	High	Pull down	N	Y (On/Off)	N	N	Y	Buy Online
TCK112G	WCSP6C	1.0x1.5	NMOS	1.1	5.5	3	8.4	8.3	65	500	High	Pull down	Y	Y (On/Off)	N	N	Y	Buy Online
TCK206G	WCSP4C	0.9x0.9	NMOS	0.75	3.6	2	18.2	N/A	22	240	High	Pull down	N	Y	N	N	N	Buy Online
TCK207G	WCSP4C	0.9x0.9	NMOS	0.75	3.6	2	18.2	N/A	22	240	High	Pull down	Y	Y	N	N	N	Buy Online
TCK208G	WCSP4C	0.9x0.9	NMOS	0.75	3.6	2	18.2	N/A	22	240	Low	Open	Y	Y	N	N	N	Buy Online
TCK207AN	DFN4A	1.2x1.2	NMOS	0.75	3.6	2	21.5	N/A	22	240	High	Pull down	Y	Y	N	N	N	Buy Online
TCK126BG	WCSP4G	0.645*0.645	PMOS	1.0	5.5	1	210	46	0.08nA	363	High	Open	N	N	N	N	N	Buy Online
TCK127BG	WCSP4G	0.645*0.645	PMOS	1.0	5.5	1	210	46	0.08nA	363	High	Open	Y	N	N	N	N	Buy Online
TCK128BG	WCSP4G	0.645*0.645	PMOS	1.0	5.5	1	210	46	0.08nA	363	Low	Open	Y	N	N	N	N	Buy Online

OAD: Output auto-discharge, Y (On/Off): "True backflow prevention function", RCB: Reverse flow prevention, OVP: Overvoltage protection (shutdown), OCP: Overcurrent protection (shutdown), TSD: Heat protection

WCSP4D	WCSP4C	SMV (SOT-25)	WCSP6C	WCSP6E	DFN4A	WCSP4G
Bottom View  0.79 x 0.79	Bottom View  0.9 x 0.9	 2.9 x 2.8	Bottom View  1.5 x 1.0	Bottom View  1.2 x 0.8	Bottom View  1.2 x 1.2	Bottom View  0.645 x 0.645

•Load switch IC selection table(Power Multiplexer ICs)

品名	パッケージ	サイズ (mm)	構造	Electrical Characteristics/Switching Characteristics							Additional function					Purchase	
				Vin / V (Min)	Vin / V (Max)	Iout / A (DC)	RON / mΩ (typ) @ 4.5V, -1.0A	Iq / μA (typ)	Slew rate / ms (typ)	Control Active	Control connection	OAD	RCB	OVP	OCP		TSD
TCK301G	WCSP9	1.5x1.5	NMOS	2.3	28	3	73	130	2	(Note1)	Pull up	N	Y	Y(6.6V)	N	Y	Buy Online
TCK302G	WCSP9	1.5x1.5	NMOS	2.3	28	3	73	130	2	(Note1)	Pull up	N	Y	Y(10.5V)	N	Y	Buy Online
TCK303G	WCSP9	1.5x1.5	NMOS	2.3	28	3	73	130	2	(Note1)	Pull up	N	Y	Y(15.5V)	N	Y	Buy Online
TCK304G	WCSP9	1.5x1.5	NMOS	2.3	28	3	73	130	2	(Note1)	Pull down	N	Y	Y(6.6V)	N	Y	Buy Online
TCK305G	WCSP9	1.5x1.5	NMOS	2.3	28	3	73	130	2	(Note1)	Pull down	N	Y	Y(10.5V)	N	Y	Buy Online
TCK321G	WCSP16C	1.9x1.9	NMOS	2.3	36	2	98	140	2	(Note1)	Pull down	N	Y	Y(12.0V)	N	Y	Buy Online
TCK322G	WCSP16C	1.9x1.9	NMOS	2.3	36	2	98	140	2	(Note1)	Pull down	N	Y	Y(15.0V)	N	Y	Buy Online
TCK323G	WCSP16C	1.9x1.9	NMOS	2.3	36	2	98	140	2	(Note1)	Pull down	N	Y	Y(15.0V)	N	Y	Buy Online

OAD: Output auto-discharge, Y (On/Off): "True backflow prevention function", RCB: Reverse flow prevention, OVP: Overvoltage protection (shutdown), OCP: Overcurrent protection (shutdown), TSD: Heat protection

Note1 : Please refer to the data sheet of each product.

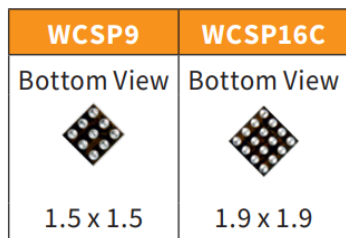

Related LINK

- [Introduction to Load Switch IC Products](#)
- [Application note](#)
- [Frequently Asked Queries for Load Switch ICs \(FAQ\)](#)
- [Online distributor purchase, inventory search page](#)
- [Cross-reference search](#)

[Click](#)

[Click](#)

[Click](#)

[Click](#)

[Click](#)

Company names, product names, and service names may be trademarks of their respective companies.

RESTRICTIONS ON PRODUCT USE

Toshiba Corporation and its subsidiaries and affiliates are collectively referred to as "TOSHIBA".

Hardware, software and systems described in this document are collectively referred to as "Product".

- TOSHIBA reserves the right to make changes to the information in this document and related Product without notice.
- This document and any information herein may not be reproduced without prior written permission from TOSHIBA. Even with TOSHIBA's written permission, reproduction is permissible only if reproduction is without alteration/omission.
- Though TOSHIBA works continually to improve Product's quality and reliability, Product can malfunction or fail. Customers are responsible for complying with safety standards and for providing adequate designs and safeguards for their hardware, software and systems which minimize risk and avoid situations in which a malfunction or failure of Product could cause loss of human life, bodily injury or damage to property, including data loss or corruption. Before customers use the Product, create designs including the Product, or incorporate the Product into their own applications, customers must also refer to and comply with (a) the latest versions of all relevant TOSHIBA information, including without limitation, this document, the specifications, the data sheets and application notes for Product and the precautions and conditions set forth in the "TOSHIBA Semiconductor Reliability Handbook" and (b) the instructions for the application with which the Product will be used with or for. Customers are solely responsible for all aspects of their own product design or applications, including but not limited to (a) determining the appropriateness of the use of this Product in such design or applications; (b) evaluating and determining the applicability of any information contained in this document, or in charts, diagrams, programs, algorithms, sample application circuits, or any other referenced documents; and (c) validating all operating parameters for such designs and applications. TOSHIBA ASSUMES NO LIABILITY FOR CUSTOMERS' PRODUCT DESIGN OR APPLICATIONS.
- PRODUCT IS NEITHER INTENDED NOR WARRANTED FOR USE IN EQUIPMENTS OR SYSTEMS THAT REQUIRE EXTRAORDINARILY HIGH LEVELS OF QUALITY AND/OR RELIABILITY, AND/OR A MALFUNCTION OR FAILURE OF WHICH MAY CAUSE LOSS OF HUMAN LIFE, BODILY INJURY, SERIOUS PROPERTY DAMAGE AND/OR SERIOUS PUBLIC IMPACT ("UNINTENDED USE"). Except for specific applications as expressly stated in this document, Unintended Use includes, without limitation, equipment used in nuclear facilities, equipment used in the aerospace industry, lifesaving and/or life supporting medical equipment, equipment used for automobiles, trains, ships and other transportation, traffic signaling equipment, equipment used to control combustions or explosions, safety devices, elevators and escalators, and devices related to power plant. IF YOU USE PRODUCT FOR UNINTENDED USE, TOSHIBA ASSUMES NO LIABILITY FOR PRODUCT. For details, please contact your TOSHIBA sales representative or contact us via our website.
- Do not disassemble, analyze, reverse-engineer, alter, modify, translate or copy Product, whether in whole or in part.
- Product shall not be used for or incorporated into any products or systems whose manufacture, use, or sale is prohibited under any applicable laws or regulations.
- The information contained herein is presented only as guidance for Product use. No responsibility is assumed by TOSHIBA for any infringement of patents or any other intellectual property rights of third parties that may result from the use of Product. No license to any intellectual property right is granted by this document, whether express or implied, by estoppel or otherwise.
- ABSENT A WRITTEN SIGNED AGREEMENT, EXCEPT AS PROVIDED IN THE RELEVANT TERMS AND CONDITIONS OF SALE FOR PRODUCT, AND TO THE MAXIMUM EXTENT ALLOWABLE BY LAW, TOSHIBA (1) ASSUMES NO LIABILITY WHATSOEVER, INCLUDING WITHOUT LIMITATION, INDIRECT, CONSEQUENTIAL, SPECIAL, OR INCIDENTAL DAMAGES OR LOSS, INCLUDING WITHOUT LIMITATION, LOSS OF PROFITS, LOSS OF OPPORTUNITIES, BUSINESS INTERRUPTION AND LOSS OF DATA, AND (2) DISCLAIMS ANY AND ALL EXPRESS OR IMPLIED WARRANTIES AND CONDITIONS RELATED TO SALE, USE OF PRODUCT, OR INFORMATION, INCLUDING WARRANTIES OR CONDITIONS OF MERCHANTABILITY, FITNESS FOR A PARTICULAR PURPOSE, ACCURACY OF INFORMATION, OR NONINFRINGEMENT.
- Do not use or otherwise make available Product or related software or technology for any military purposes, including without limitation, for the design, development, use, stockpiling or manufacturing of nuclear, chemical, or biological weapons or missile technology products (mass destruction weapons). Product and related software and technology may be controlled under the applicable export laws and regulations including, without limitation, the Japanese Foreign Exchange and Foreign Trade Law and the U.S. Export Administration Regulations. Export and re-export of Product or related software or technology are strictly prohibited except in compliance with all applicable export laws and regulations.
- Please contact your TOSHIBA sales representative for details as to environmental matters such as the RoHS compatibility of Product. Please use Product in compliance with all applicable laws and regulations that regulate the inclusion or use of controlled substances, including without limitation, the EU RoHS Directive. TOSHIBA ASSUMES NO LIABILITY FOR DAMAGES OR LOSSES OCCURRING AS A RESULT OF NONCOMPLIANCE WITH APPLICABLE LAWS AND REGULATIONS.