

Semiconductor Handling Precautions and Requests

Toshiba Electronic Devices & Storage Corporation

Jul 2024

Table of Contents

Chapter 1 Usage Notes for Semiconductor Products.....	7
Chapter 2 Safety Precautions.....	8
2.1 General Precautions Regarding Semiconductor Products.....	9
Chapter 3 General Usage Considerations	10
3.1 From Incoming to Shipping.....	10
3.1.1 Electrostatic Discharge (ESD).....	10
3.1.1.1 Work Environment Control.....	10
3.1.1.2 Controlling Operation.....	13
3.1.2 Transportation.....	14
3.1.3 Vibration, Impact and Stress.....	14
3.2 Storage	15
3.2.1 General Packaged Products.....	15
3.2.2 Moisture-Proof Packing	16
3.2.2.1 Moisture-Proof Packing General Precautions.....	16
3.3 Design	19
3.3.1 Absolute Maximum Ratings.....	19
3.3.2 Operating Range.....	20
3.3.3 Derating.....	20
3.3.4 Unused Pins	20
3.3.5 Latch-Up.....	21

3.3.6 Input/Output Protection	22
3.3.7 Load Capacitance.....	22
3.3.8 Thermal Design.....	23
3.3.9 Mechanical Stress	24
3.3.10 Interfacing	24
3.3.11 Decoupling	24
3.3.12 External Noise.....	25
3.3.13 Electromagnetic Interference.....	25
3.3.14 Peripheral Circuits	26
3.3.15 Safety Standards.....	27
3.3.16 Other	27
3.4 Inspection, Testing and Evaluation	28
3.4.1 Grounding	28
3.4.2 Inspection Sequence	28
3.5 Mounting	29
3.5.1 Lead Forming	30
3.5.2 Soldering Temperature Profile.....	31
3.5.2.1 Using a Soldering Iron (Typical Example).....	31
3.5.2.2 Using Infrared Reflow (Typical Example)	32
3.5.2.3 Using Hot Air Reflow (Typical Example).....	32
3.5.2.4 Using Solder Flow/Dip (Typical Example).....	33

3.5.3 Flux Cleaning	33
3.5.4 No Cleaning	34
3.5.5 Socket Mounting.....	34
3.5.6. Chips Mounting.....	35
3.5.7 Circuit Board Coating	35
3.5.8 Heat Sinks.....	36
3.5.9 Tightening Torque.....	37
3.5.10 Repeated Semiconductor-Product Mounting and Usage	37
3.6 Operating Environment.....	37
3.6.1 Temperature	37
3.6.2 Humidity.....	38
3.6.3 Corrosive Gases	38
3.6.4 Radioactive and Cosmic Rays.....	38
3.6.5 Strong Electrical and Magnetic Fields.....	39
3.6.6 Interference from Light (such as Ultraviolet Rays, Sunlight, Fluorescent Lamps, Incandescent Lamps).....	39
3.6.7 Dust and Oil.....	40
3.6.8 Smoke and Ignition.....	40
3.7 Disposal	40
Chapter 4 Usage Considerations Specific to Each Product Group.....	41
4.1 Optical Semiconductor Products.....	41

4.1.1 Precautions Common to All Optical Semiconductor Products	41
4.1.1.1 Moisture-Proof Packing	41
4.1.1.2 Design	41
4.1.1.3 Inspection, Test and Evaluation.....	42
4.1.1.4 Disposal.....	42
4.1.2 Photocouplers.....	42
4.1.2.1 Design.....	42
4.1.2.2 Inspection, Test and Evaluation.....	43
4.1.2.3 Mounting	43
4.1.2.4 Usage Environment.....	44
4.1.3 Fiber Couplers.....	44
4.1.3.1 Design.....	44
4.1.3.2 Inspection, Test and Evaluation.....	45
4.1.3.3 Mounting	45
4.1.3.4 Maintenance.....	46
4.2 Power Devices.....	46
4.2.1 Vibration and Impact.....	46
4.2.2 Design	47
4.2.2.1 Unused Pins	48
4.2.2.2 Latch-Up.....	48
4.2.3 Inspection, Test and Evaluation.....	49

4.2.3.1 Inspection	50
4.2.4 Mounting	50
4.3 Application Specific Standard Products and General-Purpose Linear ICs	51
4.3.1 Design	51
4.3.2 Mounting	53
4.4 Microcomputers	53
4.4.1 Design	53
4.5 ASIC.....	54
4.5.1 Design	54
4.6 CCD Image Sensors.....	54
4.6.1 Storage	54
4.6.2 Mounting	54
4.7 Precautions Specific to Product Group.....	55
4.7.1 Optical Semiconductor Products.....	55
4.7.2 Power Device.....	55
4.7.3 Application Specific Standard Products and General-Purpose Linear ICs	58
Appendix.....	59
1 Derating Concepts and Methods.....	59
1.1 Concepts of Derating	59
1.2 Methods of Derating	60
Notes.....	66

RESTRICTIONS ON PRODUCT USE.....66

Chapter 1 Usage Notes for Semiconductor Products

Even though we make a continuous effort to improve the quality and reliability of our products, semiconductor products can malfunction or fail depending on how they are used. When using our semiconductor products (hereinafter called "Product"), please consider safety design for the customer's hardware, software, and systems and their responsibilities to prevent loss of human life, bodily injury or damage to property due to a malfunction or failure of Product.



Before starting designing or using the Product, customers must read and comply with the latest information of the Product (this document, specifications, data sheets, application notes, and technical references for the Product) and the product instruction manuals and operation manuals for the application in which the Product will be used.

When using any technical contents, including product data, diagrams, and tables and information including program code, algorithms, and sample application circuits described in the above documents, for customers' products, customers must thoroughly evaluate their own products independently as well as whole systems and determine the applicability of the information in relation to the customers' responsibilities.

Chapter 2 Safety Precautions

This section lists important precautions which users of semiconductor products should observe in order to avoid injury to the user or anyone else and damage to property, and to ensure safe and correct use of our products. Please be sure that you understand the meanings of the labels and graphic symbols described below before you move on to the detailed descriptions of the precautions and comply with the precautions stated.

[Explanation of Labels]



 DANGER	 WARNING	 CAUTION
Indicates a hazardous situation which, if not avoided, will result in death or serious injury ¹ .	Indicates a hazardous situation which, if not avoided, could result in death or serious injury ¹ .	Indicates a potentially hazardous situation which, if not avoided, may result in minor or moderate injury ² . Indicates a potentially hazardous situation which, if not avoided, may result in minor injury ² or property damage ³ .

*1: Serious injury includes blindness, wounds, burns (low and high temperature), electric shock, fractures, and poisoning, etc. with long-lasting effects or that require hospitalization and/or long-term hospital visits for treatment.







*2: Minor or moderate injury includes wounds, burns, electric shock, etc. not requiring hospitalization and/or long-term hospital visits for treatment.

*3: Property damage means damage to customer or third party machines and equipment.

[Explanation of Graphic Symbols]

 Prohibited	 Instructions
Indicates prohibited actions.	Indicates actions that must be undertaken for safety purposes.

2.1 General Precautions Regarding Semiconductor Products

⚠ CAUTION	
 Prohibited	The absolute maximum ratings of a semiconductor device are a set of ratings that must not be exceeded, even for a moment. Do not exceed any of these ratings. Exceeding the rating(s) may cause the device breakdown, damage or deterioration, and may result injury by explosion or combustion.
 Prohibited	Do not insert devices in the wrong orientation or incorrectly. Make sure that the positive and negative terminals of power supplies are connected properly. Otherwise, the current or power consumption may exceed the absolute maximum rating, and exceeding the rating(s) may cause the device breakdown, damage or deterioration, and may result injury by explosion or combustion. In addition, do not use any device that is applied the current with inserting in the wrong orientation or incorrectly even just one time.
 Prohibited	Do not touch the semiconductor product and its heat sink while the semiconductor product is on or immediately after it has been turned off. Devices and Heat sinks become hot. Contact to the heat sink may result in a burn.
 Prohibited	Do not touch the lead tips of a device. Some devices have leads with sharp tips. Contact to sharp tips may result in a puncture wound.
 Instructions	Check that there is no electrical leakage before grounding measuring equipment or a solder iron. Electrical leakage may cause electric shock or the device you are testing or soldering to electrically break down.
 Instructions	On the evaluation, inspection, or test, be sure to connect the test equipment's electrodes or probes to the pins of the device before turning the power on. When you have finished, discharge any electrical charge remaining in the device. Failure to do so may cause electric shock, resulting in injury.
 Instructions	Always wear safety glasses when cutting the leads of a device with clippers or a similar tool. Failure to do so may result in eye damage from the small shavings that fly off the cut ends.

Chapter 3 General Usage Considerations

This section provides information that will help you gain a better understanding of semiconductor products so as to ensure product safety, quality and reliability.

3.1 From Incoming to Shipping

3.1.1 Electrostatic Discharge (ESD)

Semiconductor products are very sensitive to electrostatic charges. If a high voltage electricity caused by electrostatic discharge flows through a semiconductor product, the product may be destroyed. Especially, for MOS type semiconductors, as little as several tens of voltage can destroy the devices. Humans feel a discharge of two to three kV, which indicates how only a trace amount of voltage can destroy semiconductor products. Therefore, countermeasures against electrostatic charges are required.

When handling semiconductor products, be sure that the environment is protected against static electricity.

Operators should wear anti-static clothing, anti-static shoes, and a wrist strap. In addition, containers and other objects that come in direct contact with

semiconductor products should be made of materials that do not produce static electricity that would cause damage.

Control anti-static equipment at all times to ensure that it works correctly.

Please follow the precautions below. This is particularly important for those semiconductor products marked "Be careful of ESDS."



3.1.1.1 Work Environment Control

(1) When humidity decreases, static electricity readily occurs due to friction. Taking into consideration the fact that moisture-proof-packed products absorb moisture after unpacking, the relative humidity does not fall below 40%.

- (2) Be sure that all equipment such as jigs and tools installed in the work area are grounded.
- (3) Place a conductive mat over the floor of the work area or take other measure to ensure that the floor is protected against static electricity and is grounded to the earth.
(Resistance between the floor surface and ground: $1 \times 10^9 \Omega$ or less)
- (4) Place a conductive mat over the surface of worktables to ensure that the tables are grounded. (Resistance between surface and ground: 7.5×10^5 to $1 \times 10^9 \Omega$) Do not construct worktable surfaces of metallic materials. Metallic materials are low in resistance, allowing rapid discharge when a charged semiconductor product comes in contact with them directly.
- (5) Observe the following when using automated equipment:
 - (a) When picking up a semiconductor product with a vacuum, use conductive rubber in sections which come into contact with the product surface to protect against electrostatic charge.
 - (b) Avoid friction on the semiconductor-product surface to the extent possible. If rubbing is unavoidable due to the product's mechanical structure, minimize the friction plane or use material with a small friction coefficient and low electrical resistance. Also, prevent electrostatic charge by using an ionizer.
 - (c) Use a material which dissipates static electricity in sections which come in contact with semiconductor-product leads or terminals.
 - (d) Ensure that no statically charged bodies (such as work clothes or the human body) come in contact with the semiconductor products.
 - (e) Use a tape carrier that employs a low-resistance material on sections that come in contact with electrical machinery.
 - (f) Make sure that jigs and tools used in the manufacturing process do not touch the semiconductor products.
 - (g) In processing associated with package electrostatic charge, use an ionizer to neutralize the ions in the ambient environment.

- (6) Ensure that the work chairs are protected by a conductive cover and grounded to the floor by conductive castors. (Resistance between seat surface and ground: $1 \times 10^{10}\Omega$ or less)
- (7) Install anti-static mats on storage shelf surfaces and ground the mat surface. (Resistance between surface and ground: 7.5×10^5 to $1 \times 10^9\Omega$)
- (8) For semiconductor-product transport and temporary storage, use containers (boxes, jigs or bags) that are made of a material which does not produce static electricity that could damage the semiconductor product.
- (9) Make sure that cart surfaces which come in contact with product packaging are made of materials which conduct static electricity and ground the cart surfaces to the floor surface using conductive castors.
- (10) In static electricity control areas, install anti-static dedicated ground wires. Use a transmission line circuit ground wire [Type D or above], or a trunk line ground wire. In addition, separate and ground the various devices individually.
- (11) Make sure that CRT displays in the work area are protected against static charge by employing a filter, for example. Avoid turning displays on and off to the extent possible. Neglecting to do so can cause electrostatic induction in semiconductor products.
- (12) Periodically measure the charged potential of semiconductor products, systems and fixtures located in the work area to ensure that the area is free of any charge.

3.1.1.2 Controlling Operation

- (1) Operators must wear anti-static clothing and anti-static shoes (or a toe or heel strap).
- (2) Operators must wear a wrist strap grounded to earth via a resistor. (Resistance between surface and earth when worn: 7.5×10^5 to $3.5 \times 10^7 \Omega$)



- (3) Soldering irons must be grounded from the iron tip to earth and must be used at low voltages (6 to 24 V).
- (4) If the tweezers you use are likely to touch the semiconductor-product terminals, use anti-static tweezers. Do not use metallic tweezers since they are low in resistance and may cause rapid discharge when a charged semiconductor product comes in contact with them.

When using a vacuum tweezers, attach a conductive chucking pat to the tip, and connect it to a dedicated anti-static ground. In addition, follow the manufacturer's methods of use and maintenance.

- (5) Do not place semiconductor products or their containers near sources of strong electrical fields (such as above a CRT).
- (6) Place boards with mounted semiconductor products in anti-static board containers separated from one another, and do not stack them directly on top of one another. Stacking them directly on top of one another may cause frictional charge or discharge.
- (7) Ensure, to the extent possible, that any articles (such as clipboards) which are brought to a static electricity control area are constructed of anti-static materials.
- (8) When the human body is to come in direct contact with a semiconductor product, wear anti-static finger covers or gloves.
- (9) The material of equipment safety covers located near semiconductor products should have a resistance value of $1 \times 10^9 \Omega$ or less.
- (10) If a wrist strap cannot be used and there is a possibility of imparting friction to semiconductor products, use an ionizer.

(11) The transport film used in tape carrier products is manufactured from materials in which static electricity readily builds up. When using these products, use an ionizer to prevent the film from being charged. Also, to ensure that no static electricity will be applied to the copper foil area, take measures to prevent electrostatic discharge failure of peripheral equipment.

3.1.2 Transportation

- (1) Handle exterior fiberboard boxes carefully. Note that a physical shock or dropping the product can cause product damage.
- (2) Handle interior boxes with extra care. If you drop the box, products may fly out of a magazine or a tray inside, deforming their leads.
- (3) Protect products from water. Do not let products become wet from rain or snow while carrying them.
- (4) Minimize mechanical vibration and shock during transportation. Especially for wafer shipping, take special care not to cause vibrations and shock during transportation.

3.1.3 Vibration, Impact and Stress

Handle individual or packed semiconductor products with care. Dropping or applying impact to semiconductor products or packaging causes semiconductor-product damage. Ensure that they are not subjected to mechanical vibration or impact to the extent possible. Hollow canister-type and ceramic sealed semiconductor products contain unsecured wires, making them more susceptible to vibration and impact than plastic sealed semiconductor products. When the body or a connecting part of a semiconductor product is subjected to vibration, impact or stress in actual equipment, bonding fault or device destruction may result. Therefore, be sure to keep this in mind at the time of structural design.

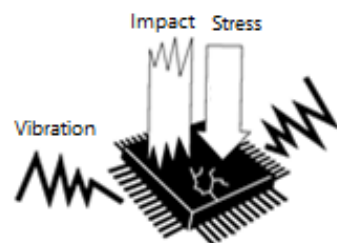

If a semiconductor product is subject to especially strong vibration, impact or stress, the package or chip may crack. If stress is applied to a semiconductor chip through the package, changes in the resistance of the chip may result due to piezoelectric effects, resulting in fluctuation in element characteristics.

Furthermore, if a stress that does not instantly result in damage is applied continually for a long period of time, product deformation may result, causing defects such as disconnection or element failure. Thus, at the time of structural design, carefully consider vibration, impact, and stress.

3.2 Storage

3.2.1 General Packaged Products

- (1) Avoid storage locations where semiconductor products may be exposed to water (wet, rain, dew condensation, etc.) or direct sunlight.
- (2) Follow the precautions printed on the packing label for transportation and storage.
- (3) Also refer to "3.1.2 Transportation" for transporting packed products.
- (4) Keep the storage location at temperature and relative humidity within a range of 5°C to 35°C and 45% to 75%, respectively.
- (5) Do not store the products in locations with poisonous gases (especially corrosive gases) and/or in dusty conditions.
- (6) Store the products in locations with minimal temperature fluctuations. Rapid temperature changes during storage can cause dew condensation, resulting in lead oxidation or corrosion, which will deteriorate the solderability of leads.
- (7) When restoring semiconductor products after removal from their packing, use anti-static containers.
- (8) Do not allow loads to be applied directly to semiconductor products while they are in storage.

3.2.2 Moisture-Proof Packing

Moisture-proof packing should be used while taking into careful consideration the handling methods specified for each packing type. If the specified procedures are not followed, the quality and reliability of the semiconductor products may be deteriorated. This section describes the general precautions for handling moisture-proof packing. Since the details may differ depending on the semiconductor products, please follow the specific delivery specification for handling packed products. If no delivery specification is designated, please seek guidance from our sales contact.

3.2.2.1 Moisture-Proof Packing General Precautions

Follow the precautions printed on the packing label for transportation and storage. To transport packed products, also refer to “3.1.2 Transportation.” For chip products, follow the respective specifications.

- (1) Do not toss or drop product packing. The aluminum laminated bag may be damaged, resulting in a loss in airtightness.
- (2) Follow the specific delivery specification for storage environment and storage temperature. If no delivery specification is designated, please seek guidance from our sales contact.
- (3) If the storage period has been exceeded, or if the 30% humidity indicator is pink when the package is opened, remove any moisture under the conditions described in the table below. The effective usage period without moisture removal after the packing has been opened and the product has been stored at 5°C to 30°C and relative humidity at 60% or less is listed on the indication label . If the effective usage period has been exceeded, or if the packing has been stored in a high-humidity environment or an environment that produces dew condensation, remove any existing moisture.
- (4) When removing the moisture from semiconductor products, protect the products from breakdown from static electricity.

(5) Moisture indicators (for your reference)

Moisture indicators detect the approximate ambient humidity level at a standard temperature of 25°C.

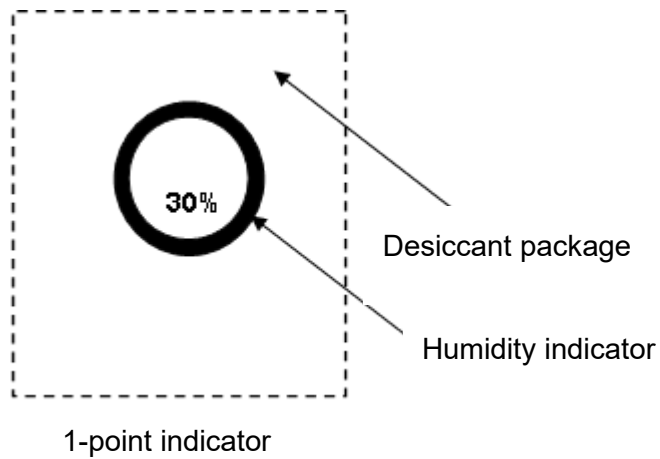

Figure 3.2.1 Humidity Indicator

(6) Do not allow loads to be applied directly to semiconductor products while they are in storage.

Table 3.2.1 Feasibility and Conditions of Moisture Removal by Packaging Forms of Semiconductor Products

Semiconductor-Product Packing Type	Feasibility and Conditions for Moisture Removal
Tray Type	<p>Since moisture-proof packing bags are not heat resistant, do not perform the baking process on them as they are.</p> <p>(1) For heat resistant trays (when there is a "Heatproof" or temperature indication) Please observe the following conditions regarding the baking process.</p> <ul style="list-style-type: none"> ① Remove the tray from the moisture-proof packing bag. ② Perform the baking process according to the instructions written on the moisture-proof bag. <p>(2) For trays that are not heat resistant (when there is not a "Heatproof" or temperature indication) Please observe the following conditions regarding the baking process.</p> <ul style="list-style-type: none"> ① Remove the tray from the moisture-proof packing bag. ② Transfer the product to another heat-resistant container with static electricity measures. ③ Perform the baking process according to the instructions written on the moisture-proof bag.
Magazine Type	<p>Since moisture-proof packing bags are not heat resistant, do not perform the baking process on them as they are.</p> <p>Please observe the following conditions regarding the baking process.</p> <ul style="list-style-type: none"> ① Remove the magazine from the moisture-proof packing bag. ② Transfer the product to another heat-resistant container with static electricity measures. ③ Perform the baking process according to the instructions written on the moisture-proof bag.
Taping Type	<p>Since moisture-proof packing bags are not heat resistant, do not perform the baking process on them as they are.</p> <p>Taping products are not heat-resistant with respect to all packing components (embossed tape, cover tape, and reel), so do not perform the baking process as they are.</p> <p>(Some products can be baked as they are, but for baking conditions please follow the instructions written on the moisture-proof bags.)</p> <p>Please observe the following conditions regarding the baking process.</p> <ul style="list-style-type: none"> ① Remove the reel from the moisture-proof packing bag. ② Transfer the product to another heat-resistant container with static electricity measures. ③ Perform the baking process according to the instructions written on the moisture-proof bag.

3.3 Design

To achieve the reliability required by an electronic device or system, it is important not only to use the semiconductor product in accordance with specified absolute maximum ratings and operating ranges, but also to consider the environment in which the equipment will be used, including factors such as the ambient temperature, humidity, vibration, impact, stress, transient noise and current surges, as well as mounting conditions which affect semiconductor-product reliability. This section describes general design precautions. Be sure to refer to the respective technical datasheets of each product at the time of design.

3.3.1 Absolute Maximum Ratings

⚠ CAUTION	
 Prohibited	The absolute maximum ratings of a semiconductor device are a set of ratings that must not be exceeded, even for a moment. Do not exceed any of these ratings. Exceeding the rating(s) may cause the device breakdown, damage or deterioration, and may result injury by explosion or combustion.

If the voltage or current on any pin exceeds the absolute maximum rating, the overvoltage or overcurrent causes the semiconductor product’s internal circuitry to deteriorate. In extreme cases, heat generated in internal circuitry can fuse wiring or cause the semiconductor chip to break down.

If the storage or operating temperature exceeds the absolute maximum rating, the semiconductor-product internal circuitry may deteriorate, and the bonded areas may open or the package airtightness may deteriorate due to the differences between the thermal expansion coefficients of the materials from which the semiconductor product is constructed. Although absolute maximum ratings differ from product to product, they essentially concern the voltage and current at each pin, the allowable power dissipation, the connecting area temperatures, and storage temperatures.

Note that the term “maximum rating” which appears in the respective technical datasheets and the like refers to “absolute maximum rating.”

3.3.2 Operating Range

The operating range is the range of conditions necessary for the semiconductor product to operate as specified in the respective technical datasheets. Care must be exercised in the design of the equipment. If a semiconductor product is used under conditions that do not exceed absolute maximum ratings but exceed the operating range, the specifications related to semiconductor-product operation and electrical characteristics may not be met, resulting in a decrease in reliability.

If greater reliability is required, derate the semiconductor product’s operating ranges for voltage, current, power and temperature before use.

3.3.3 Derating

The term “derating” refers to ensuring greater semiconductor-product reliability by setting operating ranges reduced from rated values and taking into consideration factors such as current surges and noise.

While derating generally applies to electrical stresses such as voltage, current and power, and environmental stresses such as ambient temperature and humidity. Power devices in particular have relatively large self-heating, therefore the level of junction temperature (T_j) derating greatly affects reliability.

For your reference, details are provided in the appendix. Be sure to read the appendix carefully.

3.3.4 Unused Pins

If unused pins are left open, some semiconductor products exhibit input instability, resulting in faulty operation such as a sudden increase in current consumption. In addition, if unused

output pins on a semiconductor product are connected to the power supply, GND or other output pin, the IC may malfunction or break down.

Since the treatment of unused input and output pins differs for each product and pin, please follow the explanation in the respective technical datasheets. If no treatment method is described in the respective technical datasheet, please seek guidance from our sales contact. CMOS logic IC inputs, for example, have extremely high impedance. If an input pin is left open, it can readily pick up noise and become unstable. In this case, if the input reaches an intermediate level, both the P-channel and N-channel transistors will become conductive, allowing unnecessary power supply current to flow. It is therefore necessary to ensure that the unused input gates of a semiconductor product are connected to the power supply pin or ground (GND) pin of the same product. For treatment of heat sink pins, refer to the respective technical datasheets.

3.3.5 Latch-Up

Semiconductor products sometimes transition to an inherent condition referred to as "latch-up." This condition mainly occurs in CMOS semiconductor products. This happens when a parasitic PN-PN junction (thyristor structure) built in the semiconductor product itself is turned on, causing a large current to flow between the power supply voltage and GND, eventually causing the semiconductor product to break down.

Latch-up occurs when the voltage impressed on an input or output pin exceeds the rated value, causing a large current to flow in the internal element, or when the voltage impressed on the power supply voltage pin exceeds its rated value, forcing the internal element to breakdown. Once the element falls into the latch-up state, even though the excess voltage may have been applied only for an instant, the large current continues to flow between the power supply voltage and GND, potentially causing product explosion or combustion. To avoid this problem, observe the following:

- (1) Do not allow the voltage levels on the input and output pins to rise above the power supply voltage or decrease below GND. Consider the timing during power supply activation as well.
- (2) Do not allow any abnormal noises to be applied to the semiconductor product.
- (3) Set the electrical potential of unused input pins to the power supply voltage or GND.
- (4) Do not create an output short.

3.3.6 Input/Output Protection

Wired-logic configurations in which outputs are connected together directly cannot be used since the outputs short-circuit with the configurations. Outputs should, of course, never be connected to the power supply voltage or GND. In addition, products with tri-state outputs can undergo product deterioration if a shorted output current continues for a long period of time. Design the circuit so that the tri-state outputs will not be enabled simultaneously.

3.3.7 Load Capacitance

Certain semiconductor products exhibit an increase in delay times and a large charging and discharging current if a large load capacitance is connected, resulting in noise. In addition, since outputs are shorted for a long period of time, wiring can become fused. Use the load capacitance recommended for each product.

3.3.8 Thermal Design

The failure rate of semiconductor products largely increases as the operating temperatures increase. As shown in Figure 3.3.1, the thermal stress applied to semiconductor-product internal circuitry is the sum of the ambient temperature and the temperature rise caused by the power consumption of the semiconductor product.

Please refer to the considerations for thermal design in the respective technical datasheets. To achieve even higher reliability, take into consideration the following thermal design points:

- (1) Conduct studies to ensure that the ambient temperature (T_a) is maintained as low as possible, avoiding the effects of heat generation from the surrounding area.
- (2) If the semiconductor product's dynamic power consumption is relatively large, conduct studies regarding use of forced air-cooling, circuit board composed of low thermal resistance material, and heat sinks. Such measures can lower the thermal resistance of the package.
- (3) Derate the semiconductor product's absolute maximum ratings to minimize thermal stress from power consumption.

$$\Theta_{ja} = \Theta_{jc} + \Theta_{ca}$$

$$\Theta_{ja} = (T_j - T_a)/P$$

$$\Theta_{jc} = (T_j - T_c)/P$$

$$\Theta_{ca} = (T_c - T_a)/P$$

Θ_{ja} : Thermal resistance between junction and ambient air ($^{\circ}\text{C}/\text{W}$)

Θ_{jc} : Thermal resistance between junction and package surface, or internal thermal resistance ($^{\circ}\text{C}/\text{W}$)

Θ_{ca} : Thermal resistance between package surface and ambient air, or external thermal resistance ($^{\circ}\text{C}/\text{W}$)

T_j : Junction temperature or chip temperature ($^{\circ}\text{C}$)

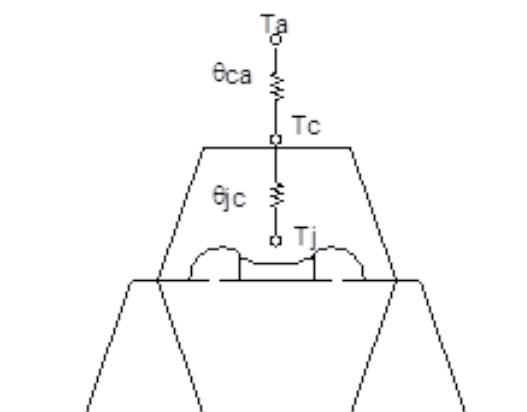

Figure 3.3.1 Thermal Resistance of Package

Tc: Package surface temperature or case temperature (°C)

Ta: Ambient temperature (°C)

P: Power consumption (W)

3.3.9 Mechanical Stress

Applying mechanical stress to packages can degrade the adhesion strength of the packages and allow moisture and contaminants to seep into the packages, thereby degrading the quality of the semiconductor products.

3.3.10 Interfacing

When connecting semiconductor products with different input and output voltage levels, make sure that the input voltage (VIL/VIH) and output voltage (VOL/VOH) levels match. Otherwise, the semiconductor products may malfunction.

To transfer data between two pins, make the input setup/hold times and the output transmission delay consistent. Otherwise, the semiconductor products may malfunction. In addition, when connecting semiconductor products with different power supply voltages, such as in a dual power supply system, semiconductor-product breakdown may result if the power-on and power-off sequences are incorrect.

For semiconductor-product interface details, refer to the respective technical datasheets. In addition, if you have any questions about interfacing, contact your nearest Toshiba office or distributor.

3.3.11 Decoupling

Spike currents generated during switching can cause power supply voltage and GND voltage levels to fluctuate, causing ringing in the output waveform or a delay in the response speed. (The power supply and GND wiring impedance is normally 50 to 100 Ω.) For this reason, the impedance of the power supply lines with respect to high frequencies must be kept low.

Specifically, this is ideally accomplished by routing thick and short power supply and GND lines and by inserting decoupling capacitors (of approximately 0.01 to 1 μF) as high-frequency filters between the power supply and GND into each required location on the circuit board.

For low-frequency filtering, it is appropriate to insert a 10 to 100 μF capacitor in each circuit board. However, conversely if the capacitance is excessively large (such as 1000 μF), latch-up may result. An appropriate capacitance value is therefore required.

On the other hand, in the case of high-speed logic ICs, noise is caused by reflection, crosstalk or common power supply impedance. Reflections cause increased signal delay, ringing, overshoot and undershoot, thereby reducing the semiconductor product's noise margin. One effective wiring measure for preventing reflections is to reduce the wiring length by increasing the mounting density so as to lower the wiring inductance (L) and capacitance (C). This measure, however, also requires consideration with regard to crosstalk between wires. In actual pattern design, both of these factors must be considered.

3.3.12 External Noise

When externally induced noise or surges are applied to a printed circuit board with long I/O signals or signal lines, malfunction may result, depending on the semiconductor product.

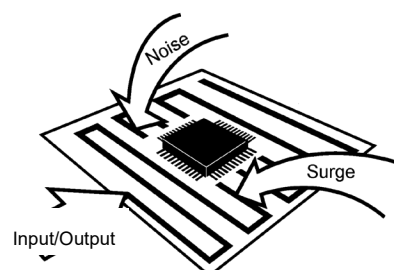

To protect against noise, protective measures against surges must be taken such as lowering the impedance of the signal line or inserting a noise-canceling circuit. For details of required protection, refer to the respective technical datasheets.

3.3.13 Electromagnetic Interference

Radio and TV reception problems have increased in recent years as a result of increased electromagnetic interference radiated from electrical and electronic equipment. To use radio waves effectively and to maintain the quality of radio communications, each country has

defined limitations for the amount of electromagnetic interference which can be generated by designated devices.

The types of electromagnetic interference include noise propagated through power supply and telephone lines, and noise from direct electromagnetic waves radiated from equipment. Different measurement methods and corrective actions are used for each type.

Difficulties in countering electromagnetic interference derive from the fact that there is no means for calculating at the design stage the strength of the electromagnetic waves produced from each component in a piece of equipment. As a result, it is after the prototype equipment has been completed that measurements are taken using dedicated instruments to determine for the first time the strength of the electromagnetic interference.

Yet it is possible during system design to incorporate measures for the prevention of electromagnetic interference, which can facilitate corrective action after design completion. One effective method, for example, is to design the product with several shielding options, and then select the optimum shielding method based on the results of the measurements subsequently taken.

3.3.14 Peripheral Circuits

In many cases semiconductor products are used with peripheral circuits and components. The input and output signal voltages and currents in these circuits must be designed to match the specifications of the semiconductor product, taking into consideration the factors below.

- (1) Input voltages and currents that are not appropriate with respect to the input pins may cause malfunction. Some semiconductor products contain pull-up or pull-down resistors, depending on specifications. Design your system taking into account the required voltage and current.
- (2) The output pins on a semiconductor product have a predetermined external circuit drive capability. If a drive capability exceeding this value is required, either insert a

compensating circuit or take that fact into account when selecting components for use in external circuits.

3.3.15 Safety Standards

Each country and region has established safety standards which must be observed. These safety standards sometimes include requirements for quality certification systems and insulation design standards. The safety standards of the respective countries and regions must be taken fully into account to ensure compliant semiconductor-product selection and design.

3.3.16 Other



- (1) When designing a system, incorporate fail-safe and other measures according to system application. In addition, debug the system under actual mounting conditions.
- (2) If a plastic package semiconductor product placed in a strong electric field, surface leakage may occur due to charge-up, resulting in malfunction. When using such a product in a strong electric field, take measures by, for example, protecting the package surface with a conductive shield.
- (3) With some memory devices and microcomputers, attention is required at power on or reset release. To ensure that your design is appropriate for a semiconductor product, refer to the respective technical datasheets.
- (4) Do not shut off the power supply while rewriting flash memory. High electric fields generated inside the package due to the power shutting off can destroy its internal elements.
- (5) Design the casing so as to ensure that no conductive material (such as a metal pin) can drop from an external source onto a terminal of a mounted semiconductor product, causing a short.

3.4 Inspection, Testing and Evaluation

3.4.1 Grounding

⚠ CAUTION	
 Instructions	Check that there is no electrical leakage before grounding measuring equipment or a solder iron. Electrical leakage may cause electric shock or the semiconductor product you are testing or soldering to electrically break down.

3.4.2 Inspection Sequence

⚠ CAUTION	
 Prohibited	Do not insert devices in the wrong orientation or incorrectly. Make sure that the positive and negative terminals of power supplies are connected properly. Otherwise, the current or power consumption may exceed the absolute maximum rating, and exceeding the rating(s) may cause the semiconductor-product breakdown, damage or deterioration, and may result injury by explosion or combustion. In addition, do not use any semiconductor product that is applied the current with inserting in the wrong orientation or incorrectly even just one time.
 Instructions	On the evaluation, inspection or test, be sure to connect the test equipment's electrodes or probes to the pins of the semiconductor product before turning the power on. When you have finished, discharge any electrical charge remaining in the semiconductor product. Failure to do so may cause electric shock, resulting in injury.

- (1) Apply voltage to the semiconductor product after inserting it into the test jig. At this time, observe the power supply activation or shutdown standards, if existent.
- (2) After test completion, be sure that the voltage applied to the semiconductor product is off before removing the semiconductor product from the test jig. Removing the semiconductor product with the power supply on can cause semiconductor-products deterioration or breakdown.



- (3) Make sure that no surge voltages from the measuring equipment are applied to the semiconductor product.
- (4) The chips in tape carrier packages (TCPs) are LSI chips and therefore exposed. During inspection, be careful not to crack or scratch the chip. Electrical contact may also cause chip failure. Therefore make sure that nothing comes into electrical contact with the chip.
- (5) Note that X-ray radiation can change product characteristics during X-ray inspection.

3.5 Mounting

There are two types of semiconductor-product packages: lead insertion and surface mount. The items that affect reliability during circuit board mounting include contamination by flux and thermal stress during the soldering process. With surface-mount packages in particular, the most significant problem is thermal stress from solder reflow, when the entire package is subjected to heat. In addition, the mounting method differs according to factors such as chip size and frame design, even for the same package type. For more details, please refer to the technical datasheet for each semiconductor product.

When a location such as a soldered area, connecting area or top surface of a product is subjected to vibration, impact or stress in actual equipment, bonding fault or device destruction may result. Therefore, be sure to keep this in mind at the time of mounting. If a product is subject to especially strong vibration, impact or stress, the package or chip may crack. Thus, at the time of mounting, carefully consider vibration, impact, and stress.

3.5.1 Lead Forming

⚠ CAUTION	
 Prohibited	Do not touch the lead tips of a device. Some devices have leads with sharp tips. Contact to sharp tips may result in a puncture wound.
 Instructions	Always wear safety glasses when cutting the leads of a device with clippers or a similar tool. Failure to do so may result in eye damage from the small shavings that fly off the cut ends.

Semiconductor products sometimes undergo a process in which the leads are cut and formed before the products are installed on a printed circuit board. If abnormal stress is applied to the interior of a semiconductor product during this process, mechanical breakdown or reliability deterioration may result. This is attributable mainly to the relative stress applied between the semiconductor product itself and the lead, and can result in internal lead damage, adhesive property deterioration and sealant breakdown. Observe the following precautions during the lead-forming process. (This does not apply to surface-mount semiconductor products.)

- (1) Lead insertion hole intervals on the printed circuit board should be designed using the same dimension standard as that for the lead interval of the semiconductor product.
- (2) If the lead insertion hole intervals on the printed circuit board do not match the lead interval of the semiconductor product, do not forcibly insert the semiconductor product.
- (3) For the minimum dimension between a semiconductor product and printed circuit board, refer to the respective technical datasheets. When necessary, create space when forming the semiconductor product's leads.

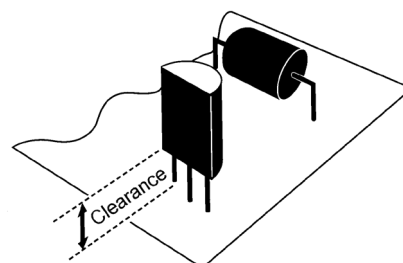

Do not use the spacers for raising semiconductor products above the surface of the printed circuit board during soldering. These spacers may continue to expand due to heat

even after the solder has solidified, sometimes applying a great amount of stress to the semiconductor product.

- (4) Observe the following when forming the leads of a semiconductor product:
- (a) When bending a lead, secure the lead at the end of the bending section near the package to ensure that mechanical stress is not applied to the semiconductor product. Also, do not repeatedly bend or stretch a lead at the same location.
 - (b) Do not damage the lead during lead forming.
 - (c) Please follow the precautions defined in the respective technical datasheets.

3.5.2 Soldering Temperature Profile

Perform soldering following the methods and conditions described in the respective technical datasheets for the semiconductor product used. The soldering method, temperature and time may be restricted, depending on the product. All soldering temperature profiles and conditions described in the mounting methods below are representative. The profiles and conditions vary from product to product. Therefore, mount the product after first confirming the information described in the respective technical datasheets and databooks with the customer. Reflow soldering and flow soldering must not be combined when performed. For details regarding special soldering including lead(Pb) soldering, please contact your nearest Toshiba office or distributor.

3.5.2.1 Using a Soldering Iron (Typical Example)

Complete soldering within 10 seconds for soldering iron temperatures of up to 260°C, or within 3 seconds for soldering iron temperatures of up to 350°C.

3.5.2.2 Using Infrared Reflow (Typical Example)

- (1) It is recommended the top and bottom heating method with long or medium infrared rays.
- (2) The maximum package surface temperature is 260°C. The duration where package surface temperature is 255°C or more must be no longer than 30 seconds.
- (3) Refer to Figure 3.5.1 for an example of a temperature profile.

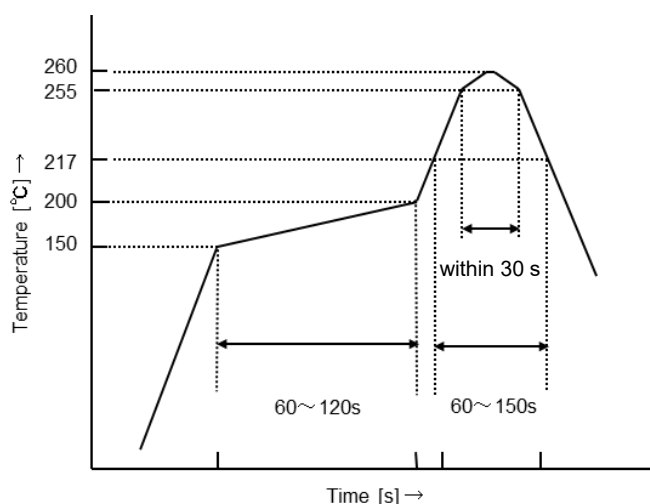

Figure 3.5.1 Example of Temperature Profile

This profile is based on the product’s maximum heat resistance guaranteed value. Set the preheat temperature/heating temperature to the optimum temperature corresponding to the solder paste type used by the customer within the above-described profile.

3.5.2.3 Using Hot Air Reflow (Typical Example)

The maximum package surface temperature is 260°C. The duration where package surface temperature is 255°C or more must be no longer than 30 seconds. For an example of a temperature profile, refer to Figure 3.5.1 above.

3.5.2.4 Using Solder Flow/Dip (Typical Example)

- (1) Apply preheating for 60 to 120 seconds at a temperature of 150°C.
- (2) Perform the solder flow at a maximum temperature of 260°C for no longer than 10 seconds.
- (3) For insertion type packages, solder the device at the stopper part or at least 1.5 mm away from the body.

3.5.3 Flux Cleaning

- (1) When cleaning circuit boards to remove flux, make sure that no reactive ions such as sodium or chlorine remain. Some organic solvents react with water to generate hydrogen chloride and other corrosive gases which can result in semiconductor-product deterioration.
Also, if the cleaning solution contains any contaminants (flux-derived halogen, etc.) that were dissolved during cleaning, can result in semiconductor-product deterioration.
- (2) When washing semiconductor products with water, make sure that no reactive ions such as sodium or chlorine remain particularly.
- (3) When washing semiconductor products, do not rub markings with a brush or with your hand while the cleansing liquid is still on the product. Doing so can rub off the markings.
- (4) Dip cleaning, shower cleaning and steam cleaning processes are performed based on the chemical action of a solvent. Washing should be performed at your own discretion, utilizing information from detergent manufacturers.
- (5) Avoid use of ultrasonic cleaning with semiconductor products in hermetically sealed ceramic packages such as a leadless chip carrier (LCC), pin grid array (PGA) or charge-coupled device (CCD). Using the ultrasonic cleaning may cause the internal wires to become disconnected due to resonance. Even if a product package allows ultrasonic cleaning, keep the duration of ultrasonic cleaning in a brief time. Long hours of ultrasonic cleaning may deteriorate the adhesion between the mold resin and frame material. The basic recommended conditions are as follows:

Recommended Ultrasonic Cleaning Conditions

Frequency : 27 to 29 kHz

Ultrasonic output: 0.15 W/cm² or less

Cleaning time : 30 seconds or less

Suspend the printed circuit board in the solvent bath to ensure that the circuit board and semiconductor products do not come in direct contact with the ultrasonic vibrator.

3.5.4 No Cleaning

It is recommended that you clean analog or high-speed semiconductor products. If such products are not cleaned, flux may cause minute leakage between leads or migration, depending on the flux grade. Be sure therefore to check cleanliness at the time of use. If you are considering no cleaning, be sure to use a flux that does not require cleaning.

3.5.5 Socket Mounting

- (1) When socket-mounting semiconductor products on a printed circuit board, use sockets that match the package.
- (2) Use sockets with contacts that have the appropriate contact pressure. If the contact pressure is insufficient, the contact may become poor when the semiconductor product is repeatedly inserted and removed. If the contact pressure is too high, the semiconductor-product leads may bend or become damaged when they are inserted into or removed from the socket.
- (3) When soldering sockets to the printed circuit board, use sockets designed to prevent flux from penetrating the contacts and to allow flux to be completely cleaned off.
- (4) Ensure that the coating agent applied to the printed circuit board for moisture-proofing does not adhere to the socket contacts.
- (5) If the leads are severely bent when inserted into or removed from a socket and you want to repair the leads and continue using the semiconductor product, repair the leads once only. Do not use products whose leads have been corrected multiple times.

- (6) If external vibration will be applied to a printed circuit board with semiconductor products mounted on it, use sockets with strong contact pressure so as to prevent vibration between the semiconductor products and sockets.

3.5.6. Chips Mounting

Semiconductor products delivered in chip form readily deteriorate or become damaged due to external factors in comparison with plastic-packaged products. Attention is therefore required during handling.

- (1) Mount semiconductor products in a properly maintained environment so that the chip will not be exposed to contaminated ambient air or other substances.
- (2) When handling chips, be careful not to expose the chips to static electricity. In particular, measures must be taken to prevent electrostatic breakdown during chip mounting. For this purpose, it is recommended that you mount all peripheral devices before you mount the chips.
- (3) Use chip mounting circuit boards (such as PCBs) that do not have any chemical residue on them (such as the chemicals used during PCB etching).
- (4) When mounting chips, use the method of assembly that is most suitable for achieving the appropriate electrical, thermal and mechanical characteristics of the semiconductor product used.

* For chip details, refer to the relevant specification sheet.

3.5.7 Circuit Board Coating

When using semiconductor products for equipment that requires high reliability or used under extreme environments (where moisture, corrosive gas or dust is present), circuit boards are sometimes coated with a moisture-proof coating. Use a coating resin causing less stress and not containing reactive components such as halogen.

3.5.8 Heat Sinks

⚠ CAUTION	
 Prohibited	Do not touch the semiconductor product and its heat sink while the device is on or immediately after the device has been turned off. Devices and Heat sinks become hot. Contact to the heat sink may result in a burn.

- (1) When installing a heat sink to a semiconductor product, use the specified accessories. In addition, be careful not to apply excessive force to the semiconductor product during installation.
- (2) When installing a semiconductor product to a heat sink by fixing it in two or more locations, do not tighten one location to the specified torque while the rest are left not tightened. Rather, lightly tighten all locations evenly first and tighten all locations to the specified torque by rotation.
- (3) Drill screw holes in the heat sink as specified, and smooth the surface of the semiconductor-product installation area by removing burrs and protrusions or indentations.
- (4) Thinly applying silicone grease between the heat sink makes semiconductor product better to improve heat conductivity compared with no grease. If you choose to apply the silicone grease, use a non-volatile type. Volatile type silicone grease can cause cracks over time, resulting in the deterioration of the heat radiation effect.
- (5) With plastic-packaged semiconductor products, the base oil of some silicone grease compounds penetrates the package interior, significantly reducing the lifetime of the semiconductor product. We ask therefore that you use the recommended silicone grease (Manufactured by Momentive Performance Materials Japan). If you choose to use another product, select an equivalent one.

3.5.9 Tightening Torque

- (1) Tighten screws to a tightening torque that is within the specified values described in the respective technical datasheets for the semiconductor product used.
- (2) Be careful not to allow a pneumatic screwdriver to come in contact with products. Product damage may result.

3.5.10 Repeated Semiconductor-Product Mounting and Usage

Do not remount or reuse semiconductor products that have histories such as that described below. These semiconductor products may cause significant problems with regard to semiconductor-product characteristics and reliability.

- (1) Semiconductor products that have been removed from the board after soldering.
- (2) Semiconductor products that have been inserted in the wrong orientation or with reverse polarity and charged.
- (3) Semiconductor products that have undergone lead forming more than once.

3.6 Operating Environment

3.6.1 Temperature

Semiconductor products are generally more sensitive to temperature than other electromechanical parts. The various electrical characteristics of a semiconductor product are restricted by the operating temperature. It is therefore necessary to understand the temperature characteristics in advance and incorporate derating into the design. When a semiconductor product is used at a temperature outside the specified operating range, electrical characteristics will not be realized and its deterioration will occur more rapidly.

3.6.2 Humidity

Plastic package semiconductor products are sometimes not completely sealed. When these products are used for an extended period of time under high humidity, moisture can seep into the semiconductor product and cause semiconductor chip deterioration or failure. Additionally, care shall be taken for using semiconductor products under conditions of dew condensation, because leads may oxidize, or ion migration may be occurred between leads. Furthermore, when products are mounted on a regular printed circuit board, the impedance between wiring can decrease under high humidity. In systems with a high signal-source impedance, circuit board leakage or leakage between semiconductor-product leads can cause malfunction. In such a case, moisture-proof treatment to the semiconductor-product surface should be considered. On the other hand, operation under low humidity can damage a semiconductor product due to the occurrence of electrostatic discharge. As a humidity environment, we request consideration in equipment design and usage targeting 40-70% relative humidity.

3.6.3 Corrosive Gases

Semiconductor products may experience corroded leads or degraded characteristics when used under corrosive gases such as SO_x, NO_x, or H₂S. Especially when corrosive gas and a high humidity environment overlap, the speed of degradation increases to a rapid pace, and a chemical reaction may cause an electrical leakage between leads. For example, sulfidizing gas may be generated from rubber products, which may lead to corrosion of device leads of semiconductor products and leakage between leads, so the use of rubber products around semiconductor products requires consideration.

3.6.4 Radioactive and Cosmic Rays

Standard semiconductor products are not designed with protection against radioactive and cosmic rays. Semiconductor products must therefore be shielded if they will be used in

environments that may result in exposure to radioactive or cosmic rays above the levels that exist in the natural environment.

Furthermore, depending on the product, unexpected errors, such as bit inversion in the memory cell and data inversion of the latch circuit, may occur due to external radiation or the influence of cosmic rays reaching the ground. This is called a soft error. When designing equipment, it is necessary to design sufficient shielding or prepare a safety design according to the operating environment of the system by applying ECC, etc.

3.6.5 Strong Electrical and Magnetic Fields

Semiconductor products exposed to magnetic fields can undergo a polarization phenomenon in the plastic material or within the chip, which gives rise to abnormal conditions such as impedance changes or leak current increases. Malfunctions have been reported in LSIs mounted near television deflection yokes. In such cases, the LSI mounted locations must be changed or the semiconductor product must be shielded against the electrical or magnetic field. Shielding against magnetism is especially required in an alternating magnetic field due to the electromotive forces generated.

3.6.6 Interference from Light (such as Ultraviolet Rays, Sunlight, Fluorescent Lamps, Incandescent Lamps)

Light striking a semiconductor product generates electromotive force due to photoelectric effects, sometimes causing malfunction. Semiconductor products in which the chip is visible through the package are especially affected by such light. When designing the circuits, make sure that the semiconductor products are protected against light interference. Not just optical semiconductor products, but all types of semiconductor products are affected by light.

3.6.7 Dust and Oil

Similar to corrosive gases, dust and oil cause chemical reactions in semiconductor products, sometimes adversely affecting product characteristics. Be sure to use semiconductor products in an environment that will not result in dust or oil adhesion. Solvent and oil contained in heat release sheets similarly may result in semiconductor product quality deterioration, characteristic deterioration or disconnection. Be sure to use such products with care.

3.6.8 Smoke and Ignition

Semiconductor products and modularized semiconductor products are not noncombustible; they can emit smoke or ignite when excessive current or failure occurs. When this happens, poisonous gases may be produced. Be sure to develop a safe design that protects the semiconductor product from excessive current so as to ensure excessive current does not flow within the product during operation or at the time of failure.

To prevent the propagation of fire caused by a smoking or ignited Toshiba product and to ensure that Toshiba products do not emit smoke or ignite due to surrounding conditions, do not use Toshiba products in close proximity to combustible thing, heat-generating thing, igniting materials or flammable materials.

3.7 Disposal

Each country and region has laws and regulations for the proper disposal of semiconductor products and packing materials. Be sure to follow these laws and regulations at the time of disposal.

Chapter 4 Usage Considerations Specific to Each Product Group

This section describes the matters specific to each product group which need to be taken into consideration. The precautions described in this section take precedence over those described in Section 3, "General Usage Considerations."

4.1 Optical Semiconductor Products

Section 4.1.1 describes the handling precautions common to all optical semiconductor products, and Sections 4.1.1 to 4.1.3 describe the handling precautions classified by product group. When using this document, be sure to read the precautions common to all semiconductor products in Section 4.1.1 as well as those specific to the semiconductor-product group used in your design.

4.1.1 Precautions Common to All Optical Semiconductor Products

4.1.2 Photocouplers

4.1.3 Fiber Couplers

4.1.1 Precautions Common to All Optical Semiconductor Products

4.1.1.1 Moisture-Proof Packing

The conditions for moisture removal for moisture-proof packing of optical semiconductor products differs from that used for regular plastic package semiconductor products packed in moisture-proof taping due to differences in their respective package resin characteristics. For details of moisture removal, refer to the respective technical datasheets.

4.1.1.2 Design

(1) Derating

Derating The lifetime characteristics of optical semiconductor products are closely associated with operating conditions, case temperature and the operating humidity environment. From this perspective, in addition to regular derating, the fluctuation and

deterioration rates for each of the product's primary characteristics (such as luminous intensity, optical output and current conversion efficiency), and the operating and environment conditions should be fully taken into consideration at the design stage.

(2) Fail-Safe Implementation

If there is a possibility that failure in optical semiconductor products, deterioration of characteristics (such as optical output, current conversion) or functional abnormality will have a significant adverse impact on the safe operation of the system, design a fail-safe measure in accordance with the system application.

4.1.1.3 Inspection, Test and Evaluation

When inspecting products, be sure to observe the standards stated in the individual technical datasheets for each product. In particular, the reverse voltage/reverse current characteristics differ according to the type of light-emitting material. If current is forced to flow in the reverse polarity, product characteristics can fail at a high rate.

4.1.1.4 Disposal

For details of the precautions related to product disposal, refer to the relevant individual technical datasheets.

4.1.2 Photocouplers

4.1.2.1 Design

(1) Dust and Oil

Dust accumulation on or oil adhesion to products causes a reduction in the product's dielectric strength between the input and the output. Also, the dust or oil may generate a chemical reaction with the product, having an adverse effect similar to corrosive gas on the product. If a reduction in the input-to-output dielectric strength of a product or an increase in leakage current through its package could critically affect system functionality, measures such as resin impregnation should be considered during at the design phase.

(2) Observing the Operating Range

The lifetime characteristics of a light-emitting device are closely associated with factors such as operating current and package temperature. From this standpoint, in addition to regular derating, the relationship between the fluctuation rate of the coupling characteristics of the product, such as the current transfer ratio (CTR) and trigger LED current (IFT), and the operating current and operating temperature should be fully taken into account in the design phase.

4.1.2.2 Inspection, Test and Evaluation

⚠ WARNING	
 Instructions	<p>When evaluating and testing the dielectric strength voltage of a photo coupler, use equipment that can shut off the supply voltage if a leakage current exceeding 100 μA is detected.</p> <p>Failure to do so may result in the continuous flow of a large short-circuit current, causing the device to explode or combust, resulting in fire or injury.</p>

(1) Dielectric Strength of a Product Between Input and Output

(a) Control Standards and Mounting Restrictions

The performance of Dielectric Strength of a Product Between Input and Output is stipulated and tested based on methods defined in UL (American), VDE (German) and other component standards. The stipulated insulation performance retention time for products is 1 minute. Therefore, use of these products in applications designed to provide long-term continuous high-voltage insulation is not recommended.

4.1.2.3 Mounting

(1) Resin Coating

- (a) Before applying resin coating, check that it will not affect the product.
- (b) Before applying resin coating, first clean off the dirt and impurities and remove the moisture from the product adequately. For the resin coating method, inform the resin

manufacturer of the voltages applied between the product's input and output and follow their instructions.

4.1.2.4 Usage Environment

Light striking a product generates electromotive force due to photoelectric effects, it may cause malfunction. Strong light such as sunlight, strobe light or a search light exposing upon a photocoupler-based system may cause the system to malfunction. A product light-shield suitable to the application is required.

4.1.3 Fiber Couplers

4.1.3.1 Design

(1) External Noise

To improve the noise resistance of an optical reception module (simplex type) and transmission/reception module (duplex type), connect the module's package-fixing reinforcement pins to the "SIGNAL-GND" when mounting. At this time, make sure that the module's package does not touch the power supply lines or any other circuits.

(2) When using an optical transmission or reception module or an optical transmission/reception module in a location that is easily affected by noise, test the product's noise resistance in advance and take the following measures as necessary:

- (a) If power supply ripples are large, enhance the noise filter connected to the power supply line.
- (b) Cover the optical transmission or optical reception module or optical transmission/reception module and the power supply filter with metal covers to enhance the shield. At this time, make sure the module's case does not come in contact with the metal cover.

(3) Dust and Oil

Products do not employ a dust-proof mechanism. When using a product in a dusty environment or in a location where oil may splash, incorporate a dust-proofing cover that

will enclose all and protect the optical transmission/reception module with the optical fibers (and connectors) connected.

(4) Vibration

When mounting optical modules in equipment subjected to a great amount of vibration, resonance or mechanical shock, incorporate a structural measure into the design to alleviate the effects. In particular, if a system with optical fibers (and optical connectors) installed is subjected to vibration or shock, the optical module's package-fixing reinforcement pins may be sheared by inertial stress. So, attention is required. Optical modules in ceramic packages are hollow and therefore require even more consideration with regard to vibration, resonance and shock in comparison with the resin-molded type.

(5) Laying Optical Fiber Cables

When laying optical fiber cables, bend them at six to ten times of the stipulated minimum bending radius.

4.1.3.2 Inspection, Test and Evaluation

(1) Optical Reception Module Output Pins

Do not connect the output pins directly to the power supply or GND. Doing so can cause a large current to flow into the product, and the product may break down. If the output pins need to be pulled up or pulled down, be sure to connect a resistor. For details on how to select the resistance value, refer to the respective technical datasheets.

4.1.3.3 Mounting

Since optical transmission/reception modules are optical components, avoid using a soldering method that will be adversely affected by flux. In addition, cleaning is not recommended. When installing optical transmission/reception modules onto a printed circuit board, follow the sequence below:

- (1) Solder the circuit components other than the optical transmission/reception module.
- (2) Clean the board.

(3) Solder the optical transmission/reception module using a solder iron.

4.1.3.4 Maintenance

- (1) When an optical module is not in use, attach a protective cap to the optical connector insertion area. Light (including external light) entering on an optical module with no protective cap particularly an optical reception module, may adversely affect the other circuits.
- (2) Toshiba recommends that you stipulate in system maintenance specifications that the system's fiber-optical output be periodically checked.







4.2 Power Devices

4.2.1 Vibration and Impact

Handle semiconductor products and packaging with care. Dropping or applying impact to products or packaging causes semiconductor-product damage. Ensure that semiconductor products and packaging are not subjected to mechanical vibration or impact to the extent possible.

Some power devices use ceramic as the insulating material. High-capacity semiconductor products are heavy. If they are dropped, the impact may adversely affect insulation performance.

4.2.2 Design

⚠ WARNING	
 Prohibited	Do not use a device under conditions that exceed its absolute maximum ratings (such as current, voltage, safe operation range, temperature). Using device with exceeded its absolute maximum ratings may cause the device to break down, causing such as a short-circuit current, which may in turn cause it to explode or combust, resulting in fire or injury.
 Instructions	Use a unit which can detect short-circuit currents and shut off the power supply if a short-circuit current occurs. If the power supply is not shut off, a large short-circuit current will flow continuously, may cause the device to explode or combust, resulting in fire or injury.
 Instructions	Design the case for enclosing your system taking into consideration the prevention of flying debris in the event the device explodes or combusts. Flying debris may cause injury.
 Instructions	Design your product so that it is used with all metal areas (other than electrodes and terminals) grounded. Even with products where the device's electrodes and metal casings are insulated, electrostatic capacitance in the product may raise the electric potential of the casing. Insulation deterioration or breakdown may cause a high voltage to be applied to the casing, causing electric shock when touched, resulting in death or serious injury.
 Instructions	When designing, the heat radiation and safety features of a system incorporating Schottky barrier diodes and high-speed rectifiers, take into consideration the device's forward and reverse losses. If the reverse current in these devices is greater than that in ordinary rectifiers, and if the operating environment is severe (such as high temperature, high voltage), the device's reverse loss may increase, causing a short-circuit current and subsequently explosion or combustion, resulting in fire or injury.
 Instructions	Be sure to design the product so that, except when the main circuits of the device are active, the main circuits will be inactive when electricity is conducted to control circuits. Malfunction of the device may cause a serious accident or injury.

4.2.2.1 Unused Pins

If a semiconductor products comprised of multiple circuits is used with its unused gates left open, the product may not only operate abnormally due to unstable inputs, but also may break down due to a sudden increase in electric current.

Apply the specified reverse bias to the unused gates to ensure that they remain inactive. For details, refer to the respective technical datasheets.



4.2.2.2 Latch-Up



Some types of IGBTs do not have sufficient tolerance against load shorting or overcurrent, resulting in latch-up. The main characteristics of IGBTs differ significantly depending on structure. Select an IGBT according to application. Once latch-up occurs, a large current may flow resulting in explosion or combustion. Thus, keep in mind the following:

- (1) Observe the reverse bias safe operation range.
- (2) Do not allow any abnormal noises to be applied to the semiconductor product.
- (3) Set the gate voltage at or below the specified value.
- (4) Be sure the gate resistance is within the specified range.
- (5) Cool the semiconductor product to ensure that the maximum junction temperature is less than or equal to the specified value.

If the above-described conditions are unclear or not stated in technical datasheets, contact Toshiba office or distributor for further information.

4.2.3 Inspection, Test and Evaluation

⚠ DANGER	
 Prohibited	Do not touch a power device while it is on or after it has been turned off and all remaining electrical charge has not yet been discharged. Touching power element with electrical charge may cause electric shock, resulting in death or serious injury.
 Instructions	When evaluating, inspecting or testing a device, be sure to connect all of the test equipment's electrodes or probes before turning the power on. When you have finished, discharge any electrical charge remaining in the device. Connecting the electrodes or probes with the power on may cause electric shock, resulting in death or serious injury.

⚠ WARNING	
 Instructions	On the evaluation, inspection or test, use protective safety tools such as device covers. The device may explode or combust due to excessive stress in the event of breakdown or arc discharge between the electrode and ground potential, resulting in fire or injury.
 Instructions	Design your product so that it is used with all metal areas (other than electrodes and terminals) grounded. Even with products where the device's electrodes and metal casings are insulated, electrostatic capacitance in the product may raise the electric potential of the casing. Insulation deterioration or breakdown may cause a high voltage to be applied to the casing, causing electric shock when touched, resulting in death or serious injury.

⚠ CAUTION	
 Instructions	On the evaluation, inspection or test, either wear protective gloves before handling or wait until the device cools down before handling. Devices become hot when operated. Even after the power supply has been turned off, residual heat may cause a burn when touched the device.

4.2.3.1 Inspection

For protection against static discharge, the gate and emitter terminals of some products with a MOS gate structure are protected with conductive tape. Do not use this tape as a gate and emitter terminal short conductor for bias proof test purposes.





4.2.4 Mounting

There are various types of power devices packages, such as modules, lead-insertion packages, surface-mount packages and flat-type packages. The electrodes, signal pins and method of attaching the package to a heat sink (such as screwing, soldering or pressure welding) are different for each type of package. For screwing and pressure welding attachment methods, tightening based on a recommended torque is required. In this case, do not fully tighten each screw individually one at a time (that is, tighten the screws together in stages).

In addition, attention is required during soldering to ensure that thermal stress is not applied to the product. To ensure that product reliability will not be impaired, products should be installed so that they remain within recommended torque and stress limits. For details, refer to the respective technical datasheets.

4.3 Application Specific Standard Products and General-Purpose Linear ICs

4.3.1 Design

⚠ CAUTION	
 Instructions	Use an appropriate power supply fuse to ensure that a large current does not continuously flow in case of over current and/or IC failure. The IC will fully break down when used under conditions that exceed its absolute maximum ratings, when the wiring is routed improperly or when an abnormal pulse noise occurs from the wiring or load, causing a large current to continuously flow and the breakdown can lead smoke or ignition. To minimize the effects of the flow of a large current in case of breakdown, set up appropriately such as fuse capacity, fusing time and insertion circuit location.
 Instructions	If your design includes an inductive load such as a motor coil, incorporate a protection circuit into the design to prevent device malfunction or breakdown caused by the current resulting from the inrush current at power ON or the negative current resulting from the back electromotive force at power OFF. For details on how to connect a protection circuit such as a current limiting resistor or back electromotive force adsorption diode, refer to the respective IC data sheets or the IC data books. IC breakdown may cause injury, smoke or ignition.
 Instructions	Use a stable power supply with ICs with built-in protection functions. If the power supply is unstable, the protection function may not operate, causing IC breakdown. IC breakdown may cause injury, smoke or ignition.
 Instructions	Carefully select external components (such as inputs and negative feedback capacitors) and load components (such as speakers), for such as power amp and regulator. If there is a large amount of leakage current such as input and/or negative feedback condenser, the DC output voltage of the IC will increase. If this increased output voltage is connected to a speaker with low input withstand voltage, over current or IC failure may cause smoke or ignition from the speaker and/or IC itself. In particular, pay attention when using a Bridge Tied Load (BTL) connection type IC that inputs DC output voltage to a speaker directly.

(1) Over current Protection Circuit

Over current protection circuits (referred to as current limiter circuits) do not necessarily protect ICs under all circumstances. If the over current protection circuits operate against the over current, clear the over current status immediately. Depending on the method of use and usage conditions, such as exceeding absolute maximum ratings can cause the over current protection circuit to not operate properly or IC breakdown before operation. In addition, depending on the method of use and usage conditions, if over current continues to flow for a long time after operation, the IC may generate heat resulting in breakdown.

(2) Thermal Shutdown Circuit

Thermal shutdown circuits do not necessarily protect ICs under all circumstances. If the thermal shutdown circuits operate against the over temperature, clear the heat generation status immediately. Depending on the method of use and usage conditions, such as exceeding absolute maximum ratings can cause the thermal shutdown circuit to not operate properly or IC breakdown before operation.

(3) Heat Radiation Design

When using an IC with large current flow such as power amp, regulator or driver, please design the device so that heat is appropriately radiated, not to exceed the specified junction temperature (T_j) at any time and condition.

These ICs generate heat even during normal use. An inadequate IC heat radiation design can lead to decrease in IC life, deterioration of IC characteristics or IC breakdown. In addition, please design the device taking into consideration the effect of IC heat radiation with peripheral components.

4.3.2 Mounting

(1) Installation to Heat Sink

Please install the power IC to the heat sink not to apply excessive mechanical stress to the IC. Excessive mechanical stress can lead to package cracks, resulting in a reduction in reliability or breakdown of internal IC chip.

In addition, depending on the IC, the use of silicon rubber may be prohibited. Check whether the use of silicon rubber is prohibited for the IC you intend to use, or not. For details of power IC heat radiation design and heat sink installation, refer to the respective technical datasheets.

4.4 Microcomputers

4.4.1 Design

(1) Use of Crystal Oscillators Other than Those Recommended

For components such as crystal oscillators that are used in the oscillation circuit of microcomputer products, use the components with usage conditions described in the individual technical datasheets and databooks.

If you plan on using components with usage conditions other than those recommended, contact our engineering department stated in the individual technical datasheet, or consult with the oscillator manufacturer.

(2) Undefined Functions

Microcomputer products have commands that are not individually defined for each product (i.e., undefined commands). These products also similarly have undefined functions (for instance, bits to which functions are not assigned in the register). Refer to the product's individual technical datasheets and do not use the undefined commands and undefined functions.

4.5 ASIC

4.5.1 Design

(1) Power Consumption Verification

At the time of design verification, take into consideration the heat generated by the semiconductor product itself as a result of factors such as power consumption (i.e., the temperature rise caused by self heat generation), and need to estimate power consumption based on information that presumes actual operating conditions. Consult with Toshiba for further details before designing.

(2) Failure Detection Rate

Toshiba uses customer-approved test data in its pre-shipment tests. To conduct a reliable pre-shipment test, test data with a high failure detection rate is required. Although a failure detection rate of 100% is required in theory, consult with Toshiba if 100% is not possible due to circumstances beyond your control.

4.6 CCD Image Sensors

4.6.1 Storage

After removing the semiconductor products from their packing boxes, do not stack them directly on top of one another.

4.6.2 Mounting



(1) If dust or dirt on the surface of the window glass, a black mark may appear on the image.

Be sure to clean the window glass surface prior to use. (For example, wipe off the dust or dirt using a soft cloth or piece of paper dampened with a small amount of organic solution such as alcohol.)



(2) When installing a CCD image sensor to a printed circuit board, do not perform lead forming. We recommend the use of an IC inserter or similar appropriate tool to attach the products to the printed circuit board.







4.7 Precautions Specific to Product Group

4.7.1 Optical Semiconductor Products

⚠ WARNING	
 Prohibited	Do not apply voltage or current into the LED device that exceeds the device's absolute maximum rating. With resin-packaged LED devices in particular, excessive voltage or current may cause the package resin to explode, scattering resin fragments, and may result injury.
 Instructions	When evaluating and testing the dielectric strength voltage of a photo coupler, use equipment that can shut off the supply voltage if a leakage current exceeding 100 μ A is detected. Failure to do so may result in the continuous flow of a large short-circuit current, causing the device to explode or combust, resulting in fire or injury.

4.7.2 Power Device

⚠ DANGER	
 Prohibited	Do not touch a power device while it is on or after it has been turned off and all remaining electrical charge has not yet been discharged. Touching power element with electrical charge may cause electric shock, resulting in death or serious injury.
 Instructions	When evaluating, inspecting or testing a device, be sure to connect all of the test equipment's electrodes or probes before turning the power on. When you have finished, discharge any electrical charge remaining in the device. Connecting the electrodes or probes with the power on may cause electric shock, resulting in death or serious injury.

⚠ WARNING	
 Prohibited	Do not use a device under conditions that exceed its absolute maximum ratings (such as current, voltage, safe operation range, temperature). Using device with exceeded its absolute maximum ratings may cause the device to break down, causing such as a short-circuit current, which may in turn cause it to explode or combust, resulting in fire or injury.
 Instructions	Use a unit which can detect short-circuit currents and shut off the power supply if a short-circuit current occurs. If the power supply is not shut off, a large short-circuit current will flow continuously, may cause the device to explode or combust, resulting in fire or injury.
 Instructions	Design the case for enclosing your system taking into consideration the prevention of flying debris in the event the device explodes or combusts. Flying debris may cause injury.
 Instructions	Design your product so that it is used with all metal areas (other than electrodes and terminals) grounded. Even with products where the device's electrodes and metal casings are insulated, electrostatic capacitance in the product may raise the electric potential of the casing. Insulation deterioration or breakdown may cause a high voltage to be applied to the casing, causing electric shock when touched, resulting in death or serious injury.
 Instructions	When designing, the heat radiation and safety features of a system incorporating Schottky barrier diodes and high-speed rectifiers, take into consideration the device's forward and reverse losses. If the reverse current in these devices is greater than that in ordinary rectifiers, and if the operating environment is severe (such as high temperature, high voltage), the device's reverse loss may increase, causing a short-circuit current and subsequently explosion or combustion, resulting in fire or injury.
 Instructions	Be sure to design the product so that, except when the main circuits of the device are active, the main circuits will be inactive when electricity is conducted to control circuits. Malfunction of the device may cause a serious accident or injury.
 Instructions	On the evaluation, inspection or test, use protective safety tools such as device covers. The device may explode or combust due to excessive stress in the event of breakdown or arc discharge between the electrode and ground potential, resulting in fire or injury.





⚠ CAUTION

Instructions

On the evaluation, inspection or test, either wear protective gloves before handling or wait until the device cools down before handling.

Devices become hot when operated. Even after the power supply has been turned off, residual heat may cause a burn when touched the device.

4.7.3 Application Specific Standard Products and General-Purpose Linear ICs

⚠ CAUTION	
 Instructions	Use an appropriate power supply fuse to ensure that a large current does not continuously flow in case of over current and/or IC failure. The IC will fully break down when used under conditions that exceed its absolute maximum ratings, when the wiring is routed improperly or when an abnormal pulse noise occurs from the wiring or load, causing a large current to continuously flow and the breakdown can lead smoke or ignition. To minimize the effects of the flow of a large current in case of breakdown, set up appropriately such as fuse capacity, fusing time and insertion circuit location.
 Instructions	If your design includes an inductive load such as a motor coil, incorporate a protection circuit into the design to prevent device malfunction or breakdown caused by the current resulting from the inrush current at power ON or the negative current resulting from the back electromotive force at power OFF. For details on how to connect a protection circuit such as a current limiting resistor or back electromotive force adsorption diode, refer to the respective IC data sheets or the IC data books. IC breakdown may cause injury, smoke or ignition.
 Instructions	If your design includes an inductive load such as a motor coil, incorporate a protection circuit into the design to prevent device malfunction or breakdown caused by the current resulting from the inrush current at power ON or the negative current resulting from the back electromotive force at power OFF. For details on how to connect a protection circuit such as a current limiting resistor or back electromotive force adsorption diode, refer to the respective IC data sheets or the IC data books. IC breakdown may cause injury, smoke or ignition.
 Instructions	Carefully select external components (such as inputs and negative feedback capacitors) and load components (such as speakers) for products such as power amp and regulator. If there is a large amount of leakage current such as input and/or negative feedback condenser, the DC output voltage of the IC will increase. If this increased output voltage is connected to a speaker with low input withstand voltage, over current or IC failure may cause smoke or ignition from the speaker and/or IC itself. In particular, pay attention when using a Bridge Tied Load (BTL) connection type IC that inputs DC output voltage to a speaker directly.

Appendix

1 Derating Concepts and Methods

1.1 Concepts of Derating

Reliability greatly changes based on the level of derating, even within rated values. In particular, the usage conditions of discrete semiconductors such as power devices are left to system designers; they affect the mean time between failures (MTBF) of a system and its useful life span. Therefore, system designers must consider the reliability characteristics of semiconductor devices and check their individual derating factors. Temperature and power derating factors particularly need be modeled with environmental conditions.

Here is an example of derating. These conditions include those for worst case scenarios, including surges.

Temperature: $T_j = 80\% T_j \text{ MAX}$ or less

*Assuming approximately 10 years of intermittent use (about three hours per day)

$T_j = 50\% T_j \text{ MAX}$ or less

*Assuming approximately 10 years of 24-hour use in applications that require high reliability

※ T_j should be replaced by a temperature rating specified in the datasheet (e.g., T_a or T_{ch}) if the product is not rated with T_j .

Voltage: 80% of the maximum rating or less (Integrated circuits: within the recommended operating range)

Current: Average current 80% of the maximum rating or less (rectifying elements: 50% of the maximum rating or less)

Peak current: 80% of the maximum rating or less

Power: 50% of the permissible maximum loss or less

For high reliability, a further derated design is required. Derating factors should be determined, referring to the technical datasheets of individual products and their reliability data. In addition, there are safe operation areas (SOAs) and other factors that must be

observed during product design. Therefore, be sure to follow the specifications of each individual component.

It is no exaggeration to say that the reliability of an end product depends on that of its constituent components. To realize high reliability, an appropriate derating design is required, considering the reliability characteristics of semiconductor devices.

1.2 Methods of Derating

One well-known method for estimating the failure rate of a semiconductor device is described in the MIL standard MIL-HDBK-217. In this method, the failure rate of a semiconductor element with respect to operating conditions is found using a failure rate prediction model based on past field data. Figure 1.2.1 shows an example of a derating curve of a transistor (low frequency, bipolar) based on the MIL standard.

This prediction method, however, classifies semiconductor devices into large groups according to application without reflecting the used technical levels and process stability, which differ for each actual device. To compensate for this, semiconductor manufacturers can use a similar failure rate derating curve based on independently accumulated field data and in-house acceleration test results, although this method is not as detailed as the MIL standard method. Figure 1.2.2 shows a derating curve of a transistor that is based on acceleration tests and field performance results obtained by Toshiba.

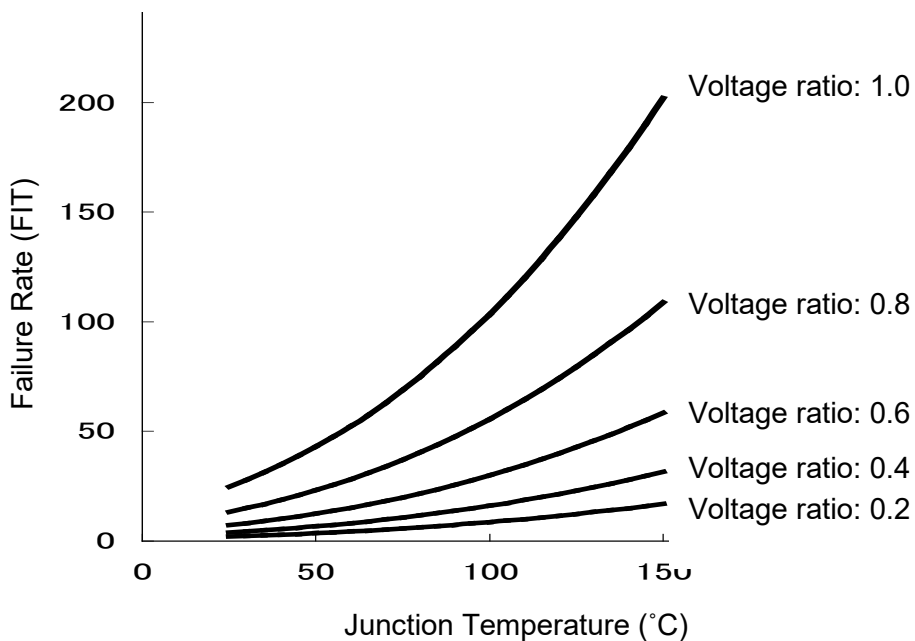

Figure 1.2.1 MIL-HDBK-217-Based Derating

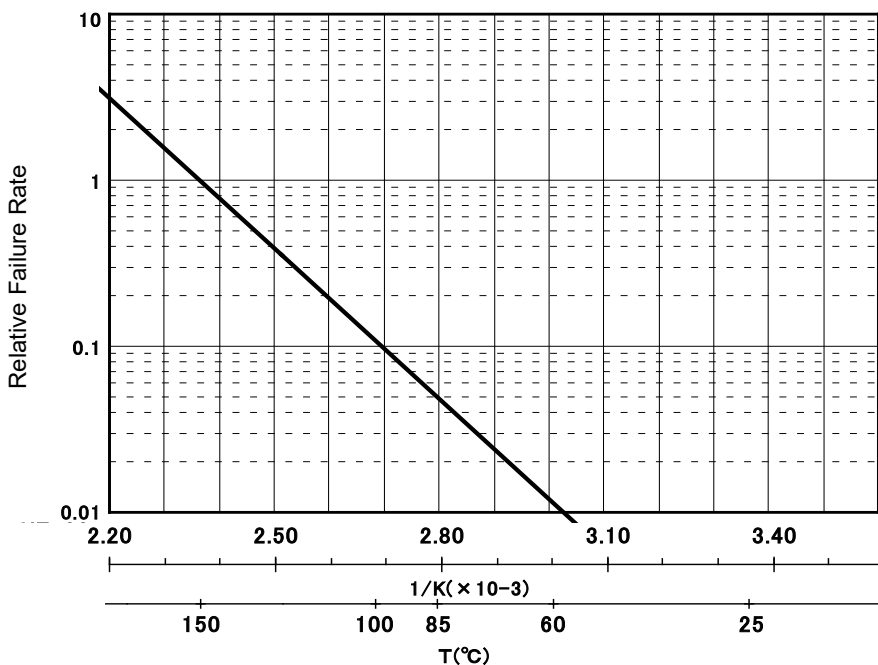
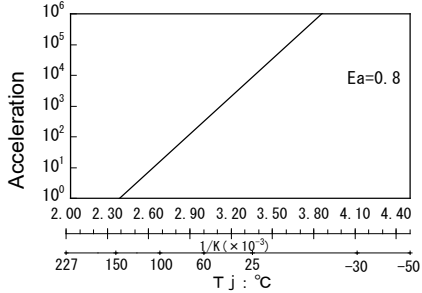

Figure 1.2.2 Transistor Derating Curve

It has been verified that Toshiba’s semiconductor products do not enter the wear-out failure period of the bathtub curve within the reliability test time. For system design, the ratings of semiconductor products must be derated so that they will not reach the wear-out failure period (within the reliability test time) in each failure mode under the assumed actual usage conditions.

The following shows how to calculate reliability test conditions for commonly used failure modes, based on the results of Toshiba’s past reliability testing.

(1) Characteristics variations (Vth, hFE, etc.)

<p>Acceleration model</p>	<p>Arrhenius model: $\alpha \propto \exp(-E_a/k \cdot 1/T)$ E_a : Activation energy (0.8eV) k : Boltzmann’s constant T : Absolute temperature (in Kelvin)</p>	
<p>Reliability test conditions</p>	<p>High-temperature operation test or high-temperature bias test; e.g., $T_j = 150^\circ\text{C}$, 1000h</p>	
<p>Assumed condition examples</p>	<p>Only the On periods are assumed</p> <ul style="list-style-type: none"> $T_j = 120^\circ\text{C}$, 10h ... (a) $T_j = 90^\circ\text{C}$, 2000h ... (b) $T_j = 60^\circ\text{C}$, 48000h ... (c) 	
<p>Conversion</p>	<p>The assumed conditions can be converted to reliability test conditions as follows (e.g., $T_j = 150^\circ\text{C}$):</p> <ul style="list-style-type: none"> (a): $\exp\{-0.8/8.617 \times 10^{-5} \cdot (1/393 - 1/423)\} \times 10\text{h} = 1.9\text{h}$ (b): $\exp\{-0.8/8.617 \times 10^{-5} \cdot (1/363 - 1/423)\} \times 2000\text{h} = 53.2\text{h}$ (c): $\exp\{-0.8/8.617 \times 10^{-5} \cdot (1/333 - 1/423)\} \times 48000\text{h} = 127.6\text{h}$ <p>(a) + (b) + (c) = 182.7h</p>	

(2) Metal interconnect faults (Delamination of bonding balls due to the growth of Au-Al alloy)

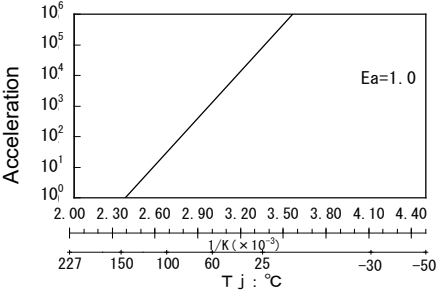
<p>Acceleration model</p>	<p>Arrhenius model: $\alpha \propto \exp(-E_a/k \cdot 1/T)$ E_a : Activation energy (1.0eV を使用) k: Boltzmann's constant T Absolute temperature (in Kelvin)</p>	
<p>Reliability test conditions</p>	<p>High-temperature storage test; e.g., $T_j = 150^\circ\text{C}$, 1000h</p>	
<p>Assumed condition examples</p>	<p>Both the On and Off periods are assumed. $T_j = 120^\circ\text{C}$, 100h ... (a) $T_j = 90^\circ\text{C}$, 7000h ... (b) $T_j = 60^\circ\text{C}$, 80000h ... (c)</p>	
<p>Conversion</p>	<p>The assumed conditions can be converted to reliability test conditions as follows (e.g., $T_j = 150^\circ\text{C}$):</p> <p>(a): $\exp\{-1.0/8.617 \times 10^{-5} \cdot (1/393 - 1/423)\} \times 100\text{h} = 12.3\text{h}$ (b): $\exp\{-1.0/8.617 \times 10^{-5} \cdot (1/363 - 1/423)\} \times 7000\text{h} = 75.2\text{h}$ (c): $\exp\{-1.0/8.617 \times 10^{-5} \cdot (1/333 - 1/423)\} \times 80000\text{h} = 48.3\text{h}$ (a) + (b) + (c) = 135.9h</p>	

(3) Metal interconnect faults (Al corrosion)

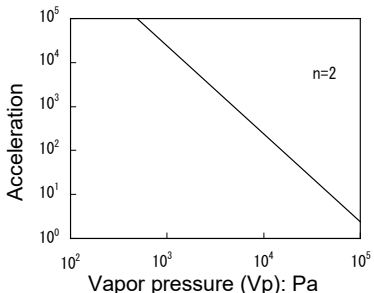
<p>Acceleration model</p>	<p>Absolute vapor pressure model: $\alpha \propto Vp^{-n}$ Vp: Absolute vapor pressure N: Acceleration factor (n = 2 is used.)</p>	
<p>Reliability test conditions</p>	<p>High-temperature/high-humidity storage test or high-temperature/high-humidity bias test; e.g., Ta = 85°C, RH = 85%, 1000h</p>	
<p>Assumed condition examples</p>	<p>Both the On and Off periods are assumed.</p> <p>Ta = 30°C/RH = 85% (Vapor pressure: 3608.2Pa), 18000h... (a) Ta = 20°C/RH = 70% (Vapor pressure: 1636.7Pa), 55000h... (b) Ta = 10°C/RH = 65% (Vapor pressure: 797.8Pa), 18000h... (c)</p> <p>*When the test equipment is on, an increase in temperature of the equipment causes the relative humidity to be decreased. It is assumed, however, that the vapor pressure remains unchanged.</p> <p>*The vapor pressure data is an excerpt from Chronological Scientific Tables compiled by the National Astronomical Observatory of Japan.</p>	
<p>Conversion</p>	<p>The assumed conditions can be converted to reliability test conditions as follows (e.g., Ta = 85°C/RH = 85% (vapor pressure: 49146.2 Pa)):</p> <p>(a): $(49146.2/3608.2)^{-2} \times 18000h = 97.0h$ (b): $(49146.2/1636.7)^{-2} \times 55000h = 61.1h$ (c): $(49146.2/797.8)^{-2} \times 18000h = 4.7h$ (a) +(b) +(c) = 162.7h</p>	

(4) Faults caused by repetitive thermal stress (package cracks, degradation of die bond)

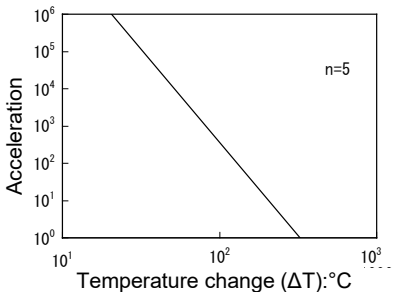
<p>Acceleration model</p>	<p>Eyring model: $\alpha \propto \Delta T^{-n}$ ΔT: Temperature change N: Acceleration factor($n = 5$ is used.)</p>	
<p>Reliability test conditions</p>	<p>Temperature cycling test; e.g., 100 cycles between -55°C and 150°C (T_a)</p>	
<p>Assumed condition examples</p>	<p>$\Delta T = 60^{\circ}\text{C}$, 7950cycles... (a) (Temperature change of the device itself and the ambience from 20°C to 80°C when the test chamber is switched on) $\Delta T = 15^{\circ}\text{C}$, 2650000cycles... (b) (Temperature change of the ambience from 80°C to 95°C when the test chamber is on)</p>	
<p>Conversion</p>	<p>The assumed conditions can be converted to reliability test conditions as follows (e.g., $\Delta T = 205^{\circ}\text{C}$): (a): $(205/60)^{-5} \times 7950$ cycles = 17.1 cycles (b): $(205/15)^{-5} \times 2650000$ cycles = 5.6 cycles (a) +(b) = 22.7 cycles</p>	

[Bibliography]

- 1) MIL-HDBK-217
- 2) JEITA EDR-4704, "Application guide of the accelerated life test for semiconductor devices"

Notes

RESTRICTIONS ON PRODUCT USE

Toshiba Corporation and its subsidiaries and affiliates are collectively referred to as "TOSHIBA".

Hardware, software, and systems described in this document are collectively referred to as "Product".

- TOSHIBA reserves the right to make changes to the information in this document and related Product without notice.
- This document and any information herein may not be reproduced without prior written permission from TOSHIBA. Even with TOSHIBA's written permission, reproduction is permissible only if reproduction is without alteration/omission.
- Though TOSHIBA works continually to improve Product's quality and reliability, Product can malfunction or fail. Customers are responsible for complying with safety standards and for providing adequate designs and safeguards for their hardware, software and systems which minimize risk and avoid situations in which a malfunction or failure of Product could cause loss of human life, bodily injury or damage to property, including data loss or corruption. Before customers use the Product, create designs including the Product, or incorporate the Product into their own applications, customers must also refer to and comply with (a) the latest versions of all relevant TOSHIBA information, including without limitation, this document, the specifications, the data sheets and application notes for Product and the precautions and conditions set forth in the "TOSHIBA Semiconductor Reliability Handbook" and (b) the instructions for the application with which the Product will be used with or for. Customers are solely responsible for all aspects of their own product design or applications, including but not limited to (a) determining the appropriateness of the use of this Product in such design or applications; (b) evaluating and determining the applicability of any information contained in this document, or in charts, diagrams, programs, algorithms,

sample application circuits, or any other referenced documents; and (c) validating all operating parameters for such designs and applications. TOSHIBA ASSUMES NO LIABILITY FOR CUSTOMERS' PRODUCT DESIGN OR APPLICATIONS.

- PRODUCT IS NEITHER INTENDED NOR WARRANTED FOR USE IN EQUIPMENTS OR SYSTEMS THAT REQUIRE EXTRAORDINARILY HIGH LEVELS OF QUALITY AND/OR RELIABILITY, AND/OR A MALFUNCTION OR FAILURE OF WHICH MAY CAUSE LOSS OF HUMAN LIFE, BODILY INJURY, SERIOUS PROPERTY DAMAGE AND/OR SERIOUS PUBLIC IMPACT ("UNINTENDED USE"). Except for specific applications as expressly stated in this document, Unintended Use includes, without limitation, equipment used in nuclear facilities, equipment used in the aerospace industry, lifesaving and/or life supporting medical equipment, equipment used for automobiles, trains, ships and other transportation, traffic signaling equipment, equipment used to control combustions or explosions, safety devices, elevators and escalators, and devices related to power plant. IF YOU USE PRODUCT FOR UNINTENDED USE, TOSHIBA ASSUMES NO LIABILITY FOR PRODUCT. For details, please contact your TOSHIBA sales representative or contact us via our website.
- Do not disassemble, analyze, reverse-engineer, alter, modify, translate, or copy Product, whether in whole or in part.
- Product shall not be used for or incorporated into any products or systems whose manufacture, use, or sale is prohibited under any applicable laws or regulations.
- The information contained herein is presented only as guidance for Product use. No responsibility is assumed by TOSHIBA for any infringement of patents or any other intellectual property rights of third parties that may result from the use of Product. No license to any intellectual property right is granted by this document, whether express or implied, by estoppel or otherwise.
- ABSENT A WRITTEN SIGNED AGREEMENT, EXCEPT AS PROVIDED IN THE RELEVANT TERMS AND CONDITIONS OF SALE FOR PRODUCT, AND TO THE MAXIMUM EXTENT ALLOWABLE BY LAW, TOSHIBA (1) ASSUMES NO LIABILITY WHATSOEVER, INCLUDING WITHOUT LIMITATION, INDIRECT, CONSEQUENTIAL, SPECIAL, OR INCIDENTAL DAMAGES OR LOSS,

INCLUDING WITHOUT LIMITATION, LOSS OF PROFITS, LOSS OF OPPORTUNITIES, BUSINESS INTERRUPTION AND LOSS OF DATA, AND (2) DISCLAIMS ANY AND ALL EXPRESS OR IMPLIED WARRANTIES AND CONDITIONS RELATED TO SALE, USE OF PRODUCT, OR INFORMATION, INCLUDING WARRANTIES OR CONDITIONS OF MERCHANTABILITY, FITNESS FOR A PARTICULAR PURPOSE, ACCURACY OF INFORMATION, OR NONINFRINGEMENT.

- Product may include products using GaAs (Gallium Arsenide). GaAs is harmful to humans if consumed or absorbed, whether in the form of dust or vapor. Handle with care and do not break, cut, crush, grind, dissolve chemically or otherwise expose GaAs in Product.
- Do not use or otherwise make available Product or related software or technology for any military purposes, including without limitation, for the design, development, use, stockpiling or manufacturing of nuclear, chemical, or biological weapons or missile technology products (mass destruction weapons). Product and related software and technology may be controlled under the applicable export laws and regulations including, without limitation, the Japanese Foreign Exchange and Foreign Trade Law and the U.S. Export Administration Regulations. Export and re-export of Product or related software or technology are strictly prohibited except in compliance with all applicable export laws and regulations.
- Please contact your TOSHIBA sales representative for details as to environmental matters such as the RoHS compatibility of Product. Please use Product in compliance with all applicable laws and regulations that regulate the inclusion or use of controlled substances, including without limitation, the EU RoHS Directive. TOSHIBA ASSUMES NO LIABILITY FOR DAMAGES OR LOSSES OCCURRING AS A RESULT OF NONCOMPLIANCE WITH APPLICABLE LAWS AND REGULATIONS.

■ Company names, product names, and service names may be trademarks of their respective companies.

Toshiba Electronic Devices & Storage Corporation

<https://toshiba.semicon-storage.com/us/>